



plastim[®]

2019

**Ürün Kataloğu ve
Fiyat Listesi Ocak**



ABS ve POLİKARBONAT PANOLAR



PANO TİPİ DELİKLİ KABLO KANALLARI



PANO İÇİ TERMOSTAT ve HİGROSTAT



PANO KLİMALARI



DAĞITICI ÜNİTELER



DESIGN SERİSİ TEPE FANLARI



PANO İKLİMLENDİRME ÜRÜNLERİ



PANO ISITICILARI



ENDÜSTRİYEL FANLAR



İZOLELİ KABLO UÇLARI



PBO SERİSİ BUTON ve AKSESUARLARI



DIN RAYLARI ve RAY TAŞIYICI

2008 yılında elektrik malzemeleri imalatını sağlamak amacıyla kurulan firmamız PLASTİM tescilli markası altında üretim hayatına başlamıştır.

Plastik elektrik panoları, pano iklimlendirme ürünleri ve delikli kablo kanalları gibi ürünlerinin Türkiye'deki önde gelen üreticilerinden biri olan Plastim Elektrik, an itibarıyla Dünya çapında 50'yi aşkın ülkeye ihracat yapmaktadır. Ürün yelpazesini de, müşterilerinin ihtiyaçları doğrultusunda sürekli genişletmekte olan Plastim Elektrik, müşterilerine en iyi hizmeti sağlamayı ve endüstriyel ihtiyaçlarını karşılamayı hedef edinmiştir.

Firmamız Ar-Ge faaliyetlerine sürekli olarak önem vererek var olan portföyüne yüksek kalitede yeni ürünler eklemeyi hedeflemektedir.

**YENİ
ÜRÜN**

DESIGN SERİSİ TEPE FANLARI



 **plastim**[®]
DESIGN



Türkiye'den dünyanın dört bir yanına



**HIZLI VE KOLAY
MONTAJ !**

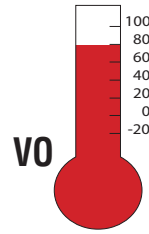

VO Alev İletmez ABS



Radyal Fan



Poliüretan Conta

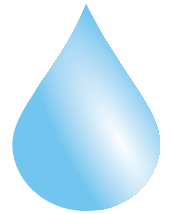

IP54

ABS ve POLİKARBONAT PANOLAR	5
ABS ve POLİKARBONAT DAĞITIM PANOLARI	7
ABS PANO AKSESUARLARI	8
PANO TİPİ DELİKLİ KABLO KANALLARI	9
DELİKLİ KANAL AKSESUARLARI	13
TEPE FANI	15
PANO İÇİ TERMOSTAT ve HİGROSTAT	18
DİJİTAL TERMOSTAT ve HİGROSTAT	19
PANO KLİMALARI	20
PANO ISITICILARI	21
DAĞITICI ÜNİTELER.....	22
SIKMALI KABLO PABUÇLARI (SKP)	23
DIN RAYLARI ve RAY TAŞIYICI	25
PET KABLO ÇORAPLARI	26
PFI SERİSİ KOLAY MONTAJLI FİLTRELER	29
PTF SERİSİ KOLAY MONTAJLI FANLI FİLTRELER	31
PTF SERİSİ KOLAY MONTAJLI FANLI FİLTRELER (24 DC).....	34
PTS SERİSİ KOLAY MONTAJLI FİLTRELER	36
ENDÜSTRİYEL FANLAR - DC BESLEME	39
ENDÜSTRİYEL FANLAR - AC BESLEME	41
ENDÜSTRİYEL FANLAR	45
AKSESUARLAR	47
İZOLELİ KABLO UÇLARI	48
PBO SERİSİ BUTON VE AKSESUARLARI	54

ABS ve POLİKARBONAT PANOLAR



POLİÜRETAN
CONTALI



IP65

CE



ABS ve POLİKARBONAT PANOLAR



POLİÜRETAN
CONTALI

IP65

CE



OPAK KAPAKLI ABS PANOLAR

KOD	ÖLÇÜ (cm)	RENK	KORUMA SINIFI	BAĞ ADEDİ	FİYAT
PP3001	20x30x13	RAL 7035 Gri	IP65	15	96.00 TL
PP3002	25x35x15	RAL 7035 Gri	IP65	15	105.00 TL
PP3004	30x40x17	RAL 7035 Gri	IP65	10	140.00 TL
PP3005	30x40x22	RAL 7035 Gri	IP65	10	177.00 TL
PP3006	35x50x19	RAL 7035 Gri	IP65	5	220.00 TL
PP3003	40x50x17,5	RAL 7035 Gri	IP65	5	224.00 TL
PP3007	40x50x24	RAL 7035 Gri	IP65	5	265.00 TL
PP3008	40x60x20	RAL 7035 Gri	IP65	5	265.00 TL
PP3010	50x70x25	RAL 7035 Gri	IP65	3	450.00 TL
PP3021	60x80x26	RAL 7035 Gri	IP65	3	750.00 TL



POLİÜRETAN
CONTALI

IP65

CE



ŞEFFAF KAPAKLI ABS POLİKARBONAT PANOLAR

KOD	ÖLÇÜ (cm)	RENK	KORUMA SINIFI	BAĞ ADEDİ	FİYAT
PP3011	20x30x13	RAL 7035 Gri	IP65	15	121.00 TL
PP3012	25x35x15	RAL 7035 Gri	IP65	15	132.00 TL
PP3014	30x40x17	RAL 7035 Gri	IP65	10	170.00 TL
PP3015	30x40x22	RAL 7035 Gri	IP65	10	205.00 TL
PP3016	35x50x19	RAL 7035 Gri	IP65	5	255.00 TL
PP3013	40x50x17,5	RAL 7035 Gri	IP65	5	280.00 TL
PP3017	40x50x24	RAL 7035 Gri	IP65	5	320.00 TL
PP3018	40x60x20	RAL 7035 Gri	IP65	5	320.00 TL
PP3020	50x70x25	RAL 7035 Gri	IP65	3	600.00 TL
PP3022	60x80x26	RAL 7035 Gri	IP65	3	980.00 TL

ABS ve POLİKARBONAT DAĞITIM PANOLARI



POLİÜRETAN
CONTALI

IP65

CE



OPAK KAPAKLI ABS OTOMAT PANOLARI

KOD	ÖLÇÜ (cm)	ÖZELLİK	RENK	KORUMA SINIFI	BAĞ ADEDİ	FİYAT
PP3102	25x35x15	18 OTOMATLI (9x2)	RAL 7035 Gri	IP65	15	162.00 TL
PP3104	30x40x17	24 OTOMATLI (12x2)	RAL 7035 Gri	IP65	10	206.00 TL
PP3106	35x50x19	45 OTOMATLI (15x3)	RAL 7035 Gri	IP65	5	355.00 TL
PP3108	40x60x20	60 OTOMATLI (15x4)	RAL 7035 Gri	IP65	5	363.00 TL



POLİÜRETAN
CONTALI

IP65

CE



ŞEFFAF KAPAKLI POLİKARBONAT OTOMAT PANOLARI

KOD	ÖLÇÜ (cm)	ÖZELLİK	RENK	KORUMA SINIFI	BAĞ ADEDİ	FİYAT
PP3112	25x35x15	18 OTOMATLI (9x2)	RAL 7035 Gri	IP65	15	207.00 TL
PP3114	30x40x17	24 OTOMATLI (12x2)	RAL 7035 Gri	IP65	10	242.00 TL
PP3116	35x50x19	45 OTOMATLI (15x3)	RAL 7035 Gri	IP65	5	430.00 TL
PP3118	40x60x20	60 OTOMATLI (15x4)	RAL 7035 Gri	IP65	5	450.00 TL

ABS PANO AKSESUARLARI

GALVANİZ TABAN SAÇLARI



KOD	KALINLIK	PANO ÖLÇÜSÜ	FİYAT
PTS3001	1mm	20x30x13cm	23.00 TL
PTS3002	1mm	25x35x15cm	26.00 TL
PTS3004	1mm	30x40x17cm	29.00 TL
PTS3005	1mm	30x40x22cm	29.00 TL
PTS3006	1mm	35x50x19cm	30.00 TL
PTS3003	1mm	40x50x17,5cm	32.00 TL
PTS3007	1mm	40x50x24cm	32.00 TL
PTS3008	1mm	40x60x20cm	42.00 TL
PTS3010	1mm	50x70x25cm	65.00 TL

MODÜLER KİTLER ve SEPERATÖRLER



KOD	AÇIKLAMA	PANO ÖLÇÜSÜ	FİYAT
PMK3102	Modüler Pano İç Montaj Kiti 18 (9x2) Otomat	25x35x15cm	26.00 TL
PMK3104	Modüler Pano iç Montaj Kiti 24 (12x2) Otomat	30x40x17cm	30.00 TL
PMK3106	Modüler Pano iç Montaj Kiti 45 (15x3) Otomat	35x50x19cm	48.00 TL
PMK3108	Modüler Pano iç Montaj Kiti 60 (15x4) Otomat	40x60x20cm	61.00 TL
PMS3102	PP3102-PP3112 için Plastik Perde	25x35x15cm	19.00 TL
PMS3104	PP3104-PP3114 için Plastik Perde	30x40x17cm	26.00 TL
PMS3106	PP3106-PP3116 için Plastik Perde	35x50x19cm	39.00 TL
PMS3108	PP3108-PP3118 için Plastik Perde	40x60x20cm	42.00 TL

PANO AKSESUARLARI



PPA01



PPA02



PPA03



PPA04

KOD	AÇIKLAMA	FİYAT
PPA01	Kilit Göbek Takımı	9.80 TL
PPA02	Pano Duvara Tuturma Aparatı (4'lü Set)	13.00 TL
PPA03	Plastik Üçgen Anahtar	5.20 TL
PPA04	Pano Seperatörü Tuturma Vidası	5.20 TL

PANO TİPİ DELİKLİ KABLO KANALLARI

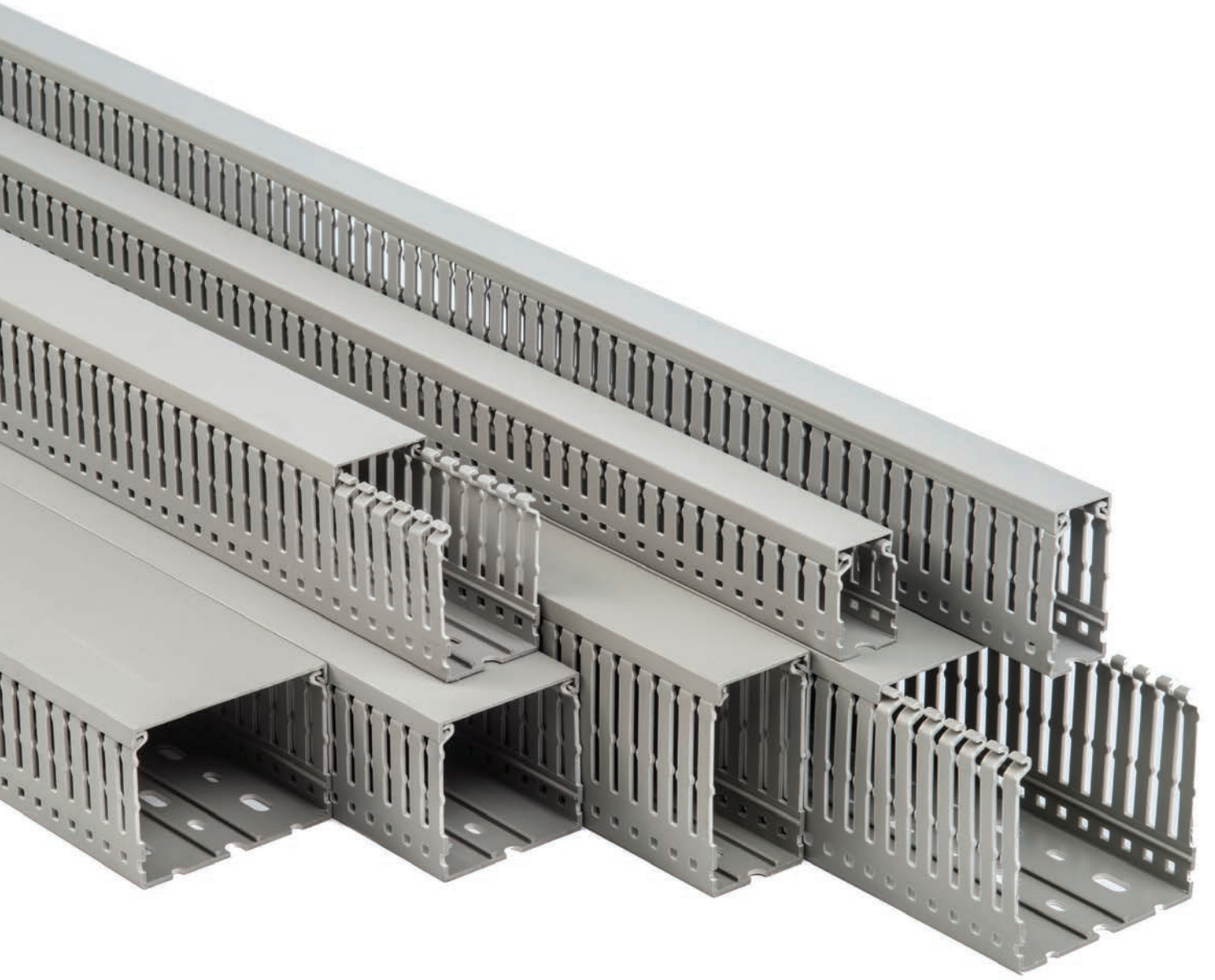

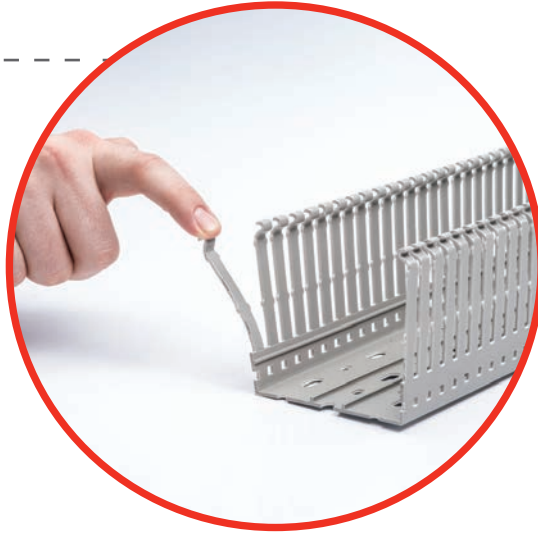
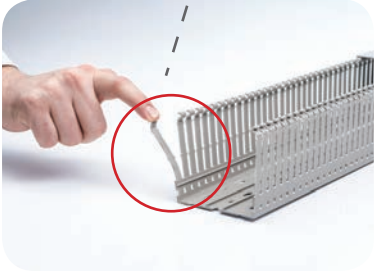

1. Kırılma Noktası

Üst kırılma noktası sayesinde herhangi bir el aletine ihtiyaç duymadan kanal yanlarında bulunan tırnakların kolayca kırılarak hızlı montaj sağlanması.

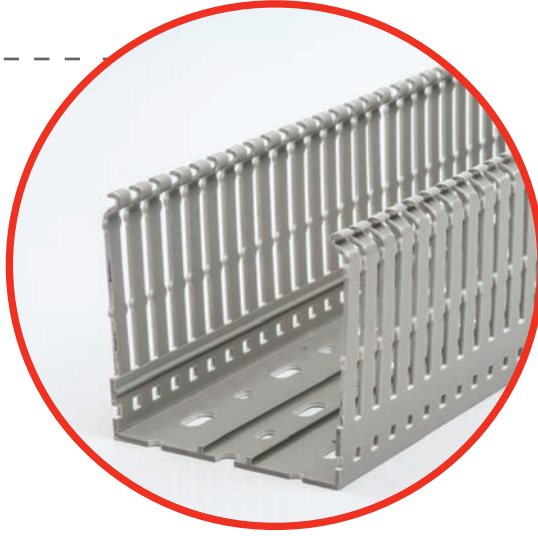
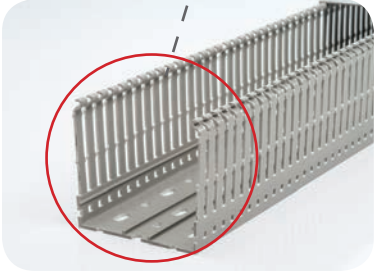

Taban Rayları

Tabanda bulunan raylar sayesinde kanal tutucu vb. aksesuarların kolayca montajı.

PLASTİM PDK6060 RoHS CE

2. Kırılma Noktası

Alt kırılma noktası sayesinde yan keski vb. alet kullanarak kanal yan duvarının kolayca kırılarak hızlı montaj sağlanması.

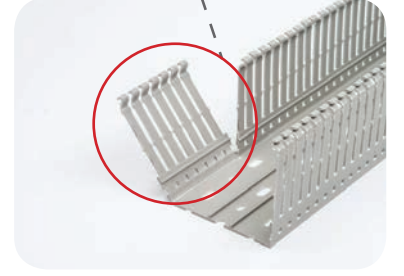
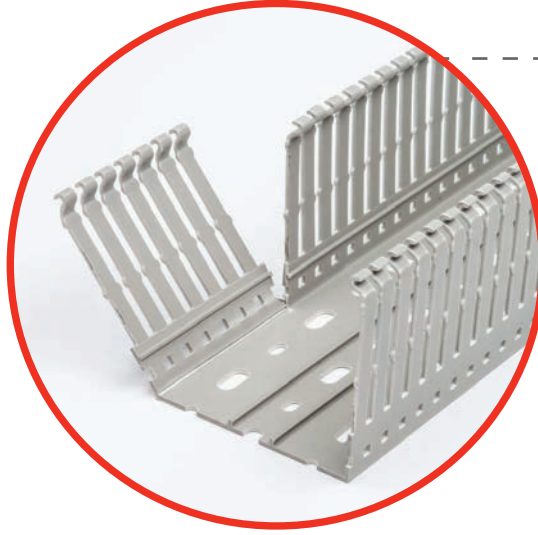

Özel Kapak Dizaynı

Özel kapak dizaynı sayesinde kolay kapanma ve açılma, dikey pozisyonda dahi en iyi performans.

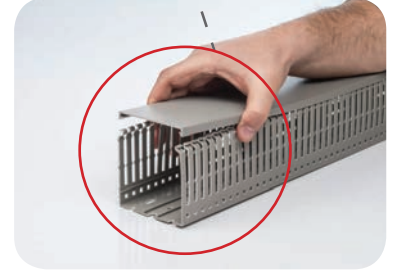
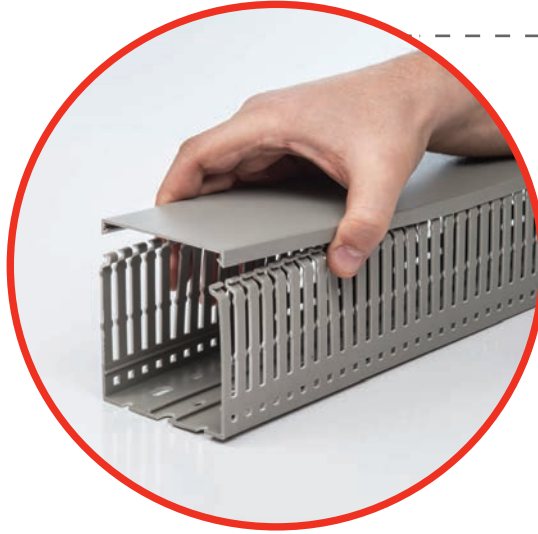

N50085 2-3 MADE IN TURKEY

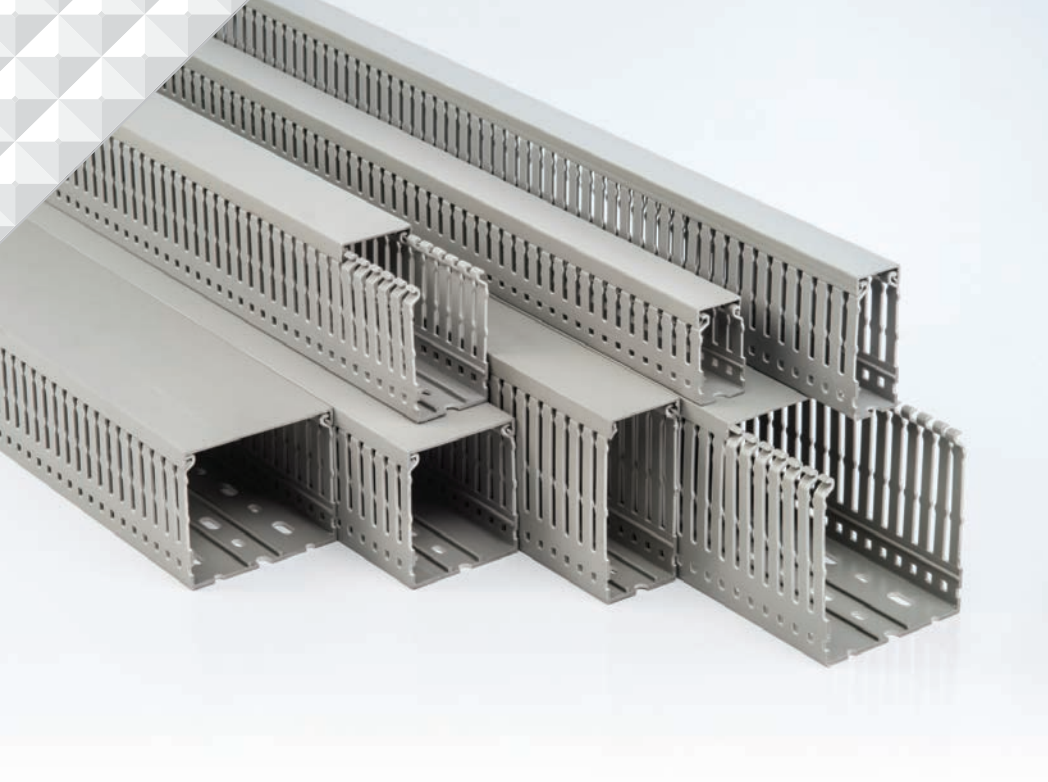

PANO TİPİ DELİKLİ KABLO KANALLARI

- UL94-VO Alev İletmez
- EN-50085 2-3
- Renk RAL 7030 Gri
- CE
- RoHS



DELİKLİ KABLO KANALLARI

KOD	ÖLÇÜ (mm)	SLOT ARALIĞI (mm)	RENK	AMBALAJ / ADET	FİYAT
PDK 2540	25x40	4/6/4 mm	RAL 7030 Gri	64x2m	12.50 TL
PDK 2560	25x60	4/6/4 mm	RAL 7030 Gri	48x2m	21.00 TL
PDK 2580	25x80	4/6/4 mm	RAL 7030 Gri	32x2m	26.00 TL
PDK 4040	40x40	4/6/4 mm	RAL 7030 Gri	35x2m	18.00 TL
PDK 4060	40x60	4/6/4 mm	RAL 7030 Gri	30x2m	24.00 TL
PDK 4080	40x80	4/6/4 mm	RAL 7030 Gri	20x2m	34.00 TL
PDK 4010	40x100	5/8/5 mm	RAL 7030 Gri	20x2m	41.00 TL
PDK 6040	60x40	4/6/4 mm	RAL 7030 Gri	25x2m	26.00 TL
PDK 6060	60x60	4/6/4 mm	RAL 7030 Gri	24x2m	31.00 TL
PDK 6080	60x80	4/6/4 mm	RAL 7030 Gri	16x2m	41.00 TL
PDK 6010	60x100	5/8/5 mm	RAL 7030 Gri	16x2m	48.00 TL
PDK 8060	80x60	4/6/4 mm	RAL 7030 Gri	14x2m	39.00 TL
PDK 8080	80x80	4/6/4 mm	RAL 7030 Gri	12x2m	48.00 TL
PDK 8010	80x100	5/8/5 mm	RAL 7030 Gri	12x2m	68.00 TL
PDK 1060	100x60	4/6/4 mm	RAL 7030 Gri	10x2m	50.00 TL
PDK 1080	100x80	4/6/4 mm	RAL 7030 Gri	10x2m	60.00 TL
PDK 1010	100x100	5/8/5 mm	RAL 7030 Gri	8x2m	95.00 TL
PDK 1260	120x60	4/6/4 mm	RAL 7030 Gri	10x2m	62.00 TL
PDK 1280	120x80	4/6/4 mm	RAL 7030 Gri	8x2m	83.00 TL

DELİKLİ KANAL AKSESUARLARI

DELİKLİ KANAL KAPAKLARI



KOD	ÖLÇÜ (mm)	RENK	AMBALAJ / ADET	FİYAT
PDC 25	25	RAL 7030 Gri	50 Adet	6.00 TL
PDC 40	40	RAL 7030 Gri	50 Adet	10.00 TL
PDC 60	60	RAL 7030 Gri	50 Adet	16.00 TL
PDC 80	80	RAL 7030 Gri	50 Adet	25.00 TL
PDC 100	100	RAL 7030 Gri	50 Adet	36.00 TL
PDC 120	120	RAL 7030 Gri	50 Adet	41.00 TL

AKSESUARLAR / KABLO TUTUCULAR



KOD	ÖLÇÜ (mm)	RENK	AMBALAJ / ADET	FİYAT
PKT 4040	40x40	RAL 7030 Gri	10 Adet	7.00 TL
PKT 4060	40x60	RAL 7030 Gri	10 Adet	8.00 TL
PKT 6080	60x80	RAL 7030 Gri	10 Adet	10.00 TL



PDC 110



PDC 250

KANAL KESME MAKASI

KOD	MAX. KESİM ÖLÇÜSÜ	AMBALAJ / ADET	FİYAT
PDC 110	60mm	1 Adet	2.925.00 TL
PDC 250	150mm	1 Adet	6.825.00 TL

PANO İKLİMLENDİRME ÜRÜNLERİ





DESIGN SERİSİ TEPE FANLARI



IP54



Poliüretan Conta



Radyal Fan

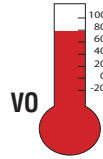

VO Alev İletmez ABS



Hızlı ve Kolay Montaj



plastim®

DESIGN

TEPE FANI



Standart

Hızlı Bağlantı

KOD	FAN TİPİ	BESLEME	GÜÇ	NOMİNAL AKIM	GÜRÜLTÜ SEVİYESİ	KAPASİTE	FİYAT
PFF 4000	Ø172x163x51 AKSİYEL	220v AC 50/60hz	25/32W	0,11/0,15A	57dB	400m ³ /h	100.00 \$
PFF 5500	Ø190x68 RADYAL	220v AC 50/60hz	58/75W	0,26/0,34A	62dB	560m ³ /h	140.00 \$
PFF 6000	Ø220x71 RADYAL	220v AC 50/60hz	85/90W	0,38/0,44A	73dB	970m ³ /h	150.00 \$
PFF 5500-110	Ø190x68 RADYAL	110v AC 50/60hz	60/73W	0,54/0,64A	63dB	560m ³ /h	160.00 \$
PFF 6000-110	Ø220x71 RADYAL	110v AC 50/60hz	83/93W	0,79/0,81A	70dB	970m ³ /h	170.00 \$



IP54



Poliüretan Conta



Radyal Fan



VO Alev İletmez ABS

TEKNİK RESİM

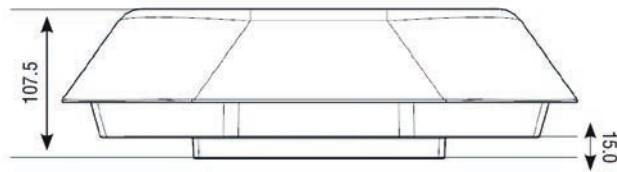
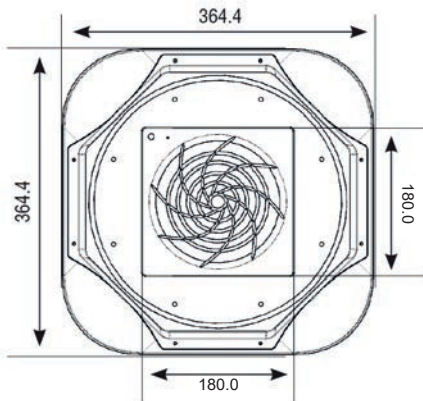

TEPE FANI DESIGN SERİSİ

YENİ
ÜRÜN



KOD	FAN TİPİ	BESLEME	GÜÇ	NOMİNAL AKIM	GÜRÜLTÜ SEVİYESİ	KAPASİTE	FİYAT
PTS 4000	Ø172x163x51 AKSİYEL	220v AC 50/60hz	25/32W	0,11/0,15A	57dB	400m ³ /h	100.00 \$
PTS 5500	Ø190x68 RADYAL	220v AC 50/60hz	58/75W	0,26/0,34A	62dB	560m ³ /h	140.00 \$
PTS 6000	Ø220x71 RADYAL	220v AC 50/60hz	85/90W	0,38/0,44A	73dB	970m ³ /h	150.00 \$
PTS 5500-110	Ø190x68 RADYAL	110v AC 50/60hz	60/73W	0,54/0,64A	63dB	560m ³ /h	160.00 \$
PTS 6000-110	Ø220x71 RADYAL	110v AC 50/60hz	83/93W	0,79/0,64A	70dB	970m ³ /h	170.00 \$



IP54



Poliüretan Conta



Radyal Fan

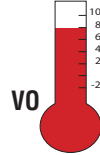

VO Alev İletmez ABS



Hızlı ve Kolay Montaj

TEKNİK RESİM

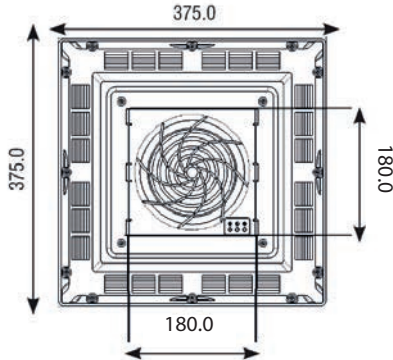

PANO İÇİ TERMOSTAT ve HİGROSTAT

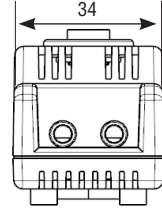
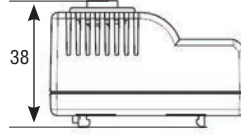
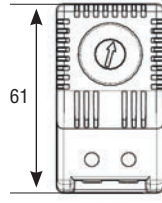

Ağırlık: 45gr
Koruma Sınıfı: IP20

AÇIKLAMA	AYAR SAHASI	KONTAK TİPİ	KORUMA SINIFI	KOD	KOLİ ADEDİ
ISITMA TERMOSTATI	0-60C	NK	IP20	PTHT	135

PTHT - TERMOSTAT - NK

FİYAT: 9.00 \$

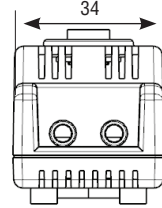
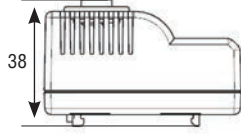
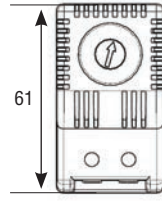

Ağırlık: 45gr
Koruma Sınıfı: IP20

AÇIKLAMA	AYAR SAHASI	KONTAK TİPİ	KORUMA SINIFI	KOD	KOLİ ADEDİ
SOĞUTMA TERMOSTATI	0-60C	NA	IP20	PTVT	135

PTVT - TERMOSTAT - NA

FİYAT: 9.00 \$

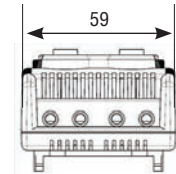
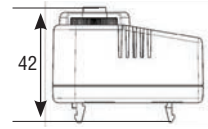
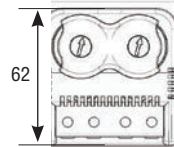

Ağırlık: 80gr
Koruma Sınıfı: IP20

AÇIKLAMA	AYAR SAHASI	KONTAK TİPİ	KORUMA SINIFI	KOD	KOLİ ADEDİ
DUAL TERMOSTAT	0-60C / 0-60C	NK+NA	IP20	PTHVT	60

PTHVT - TERMOSTAT - NK+NA

FİYAT: 20.00 \$

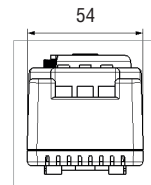
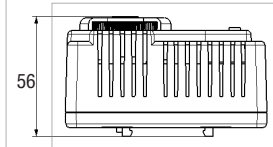
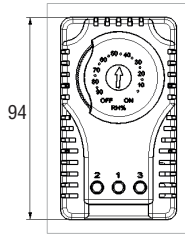

Ağırlık: 180gr
Koruma Sınıfı: IP20

AÇIKLAMA	AYAR SAHASI	KONTAK TİPİ	KORUMA SINIFI	KOD	KOLİ ADEDİ
MEKANİK HİGROSTAT	%10-90RH	1C0	IP20	PHG02	30

PHG02 - HİGROSTAT

FİYAT: 50.00 \$

DİJİTAL TERMOSTAT ve HİGROSTAT

PDT 50-150 SICAKLIK KONTROL CİHAZI

FİYAT: 60.00 \$

TEKNİK ÖZELLİKLER

Ebatlar	: 36x90x65mm raya monte
Gösterge	: 3 Hane 7 Segment
Sensör	: PTC
Ölçme Sıkalası	: -50...+150 °C
Duyarlılık	: \pm °C
Doğruluk	: \pm %1 (Tam Skalanın)
Kontrol Durumu	: ON-OFF
Out Çıkışı	: Röle, 250VAC, 2A, Rezistif Yük
Alarm Çıkışı	: Röle, 250VAC, 2A, Rezistif Yük
Heat set Ayarı	: LoL...UPL °C (Hst)
Alarm Set Ayarı	: AtP=Abs,-Ab; LoL...°C (Ast) AtP=rEL, -rL; (HSt+rAL) ,(HSt-20) ... (Hst+20) °C
Heat Histeresiz	: 1...20°C (Hhs)
Alarm Histeresiz	: 1...20°C (Hhs)
Offset	: -20...+20°C (OFS)
Isıtma/Soğutma	: H-C; Ht(Isıtma), CL (soğutma); seçmeli
Besleme Voltajı	: 100...240VAC, 50/60 Hz
Güç Tüketimi	: <6VA
Çalışma Sıcaklığı	: -20°C...55°C
İşletme İrtifası	: <2000m

NOT : PTC Sensör cihaz dahilindedir.



HT-310 SICAKLIK VE NEM KONTROL CİHAZI

FİYAT: 80.00 \$

TEKNİK ÖZELLİKLER

Ebatlar	: 35x77mm
Gösterge	: 3 Hane 7 Segment
Sensör	: Dijital Sıcaklık Nem Sensörü
Ölçme Sıkalası	: -19,9..+80,0 °C, 5 .. 95%RH
Duyarlılık	: \pm 0,1 °C, \pm 1%RH
Doğruluk	: \pm %1 (°C), \pm %3 (%RH); tam skalanın
Kontrol Durumu	: ON-OFF
°C Out Çıkışı	: Röle (NA+ NK), 250VAC, 2A, Rezistif yük
%RH Out Çıkışı	: Röle, (NA),250VAC, 2A, Rezistif Yük
Isıtma/Soğutma	: Ht (ısıtma), CL(soğutma); seçilebilir
Nem Fonksiyonu	: lo (nem alma), hi (nem verme); seçilebilir
Besleme Voltajı	: 100...220VAC, 50 / 60Hz
Güç Tüketimi	: <6VA
Çalışma Sıcaklığı	: 0...50°C
İşletme İrtifası	: <2000m

NOT : Sıcaklık ve nem sensörü cihaz dahilindedir.



PANO KLİMALARI



STANDART



INOX PASLANMAZ



IP65 HARİCİ TİP

AÇIKLAMA	SOĞUTMA GÜCÜ	BESLEME	RENK	KOD	FİYAT
STANDART PANO KLİMASI	400 W	230V 50/60 Hz	RAL 7035	PAC 040.01	920.00 €
STANDART PANO KLİMASI	500 W	230V 50/60 Hz	RAL 7035	PAC 050.01	1.050.00 €
STANDART PANO KLİMASI	750 W	230V 50/60 Hz	RAL 7035	PAC 075.01	1.200.00 €
STANDART PANO KLİMASI	1000 W	230V 50/60 Hz	RAL 7035	PAC 100.01	1.400.00 €
STANDART PANO KLİMASI	1500 W	230V 50/60 Hz	RAL 7035	PAC 150.01	1.580.00 €
STANDART PANO KLİMASI	2000 W	230V 50/60 Hz	RAL 7035	PAC 200.01	2.050.00 €
STANDART PANO KLİMASI	2500 W	230V 50/60 Hz	RAL 7035	PAC 250.01	2.450.00 €
INOX PANO KLİMASI	400 W	230V 50/60 Hz	INOX	PAC 040.02	1.100.00 €
INOX PANO KLİMASI	500 W	230V 50/60 Hz	INOX	PAC 050.02	1.250.00 €
INOX PANO KLİMASI	750 W	230V 50/60 Hz	INOX	PAC 075.02	1.400.00 €
INOX PANO KLİMASI	1000 W	230V 50/60 Hz	INOX	PAC 100.02	1.600.00 €
INOX PANO KLİMASI	1500 W	230V 50/60 Hz	INOX	PAC 150.02	1.780.00 €
INOX PANO KLİMASI	2000 W	230V 50/60 Hz	INOX	PAC 200.02	2.250.00 €
INOX PANO KLİMASI	2500 W	230V 50/60 Hz	INOX	PAC 250.02	2.650.00 €
IP65 PANO KLİMASI	400 W	230V 50/60 Hz	RAL 7035	PAC 040.03	1.100.00 €
IP65 PANO KLİMASI	500 W	230V 50/60 Hz	RAL 7035	PAC 050.03	1.250.00 €
IP65 PANO KLİMASI	750 W	230V 50/60 Hz	RAL 7035	PAC 075.03	1.400.00 €
IP65 PANO KLİMASI	1000 W	230V 50/60 Hz	RAL 7035	PAC 100.03	1.600.00 €
IP65 PANO KLİMASI	1500 W	230V 50/60 Hz	RAL 7035	PAC 150.03	1.780.00 €
IP65 PANO KLİMASI	2000 W	230V 50/60 Hz	RAL 7035	PAC 200.03	2.250.00 €
IP65 PANO KLİMASI	2500 W	230V 50/60 Hz	RAL 7035	PAC 250.03	2.650.00 €

KOD	A(mm)	B(mm)	C(mm)	AĞIRLIK(kg)
PAC040	500	200	240	14.00
PAC050	500	205	310	18.00
PAC075	610	210	320	26.30
PAC100	640	210	320	28.50
PAC150	800	255	400	32.00
PAC200	1000	255	400	43.50
PAC250	1000	255	400	44.00

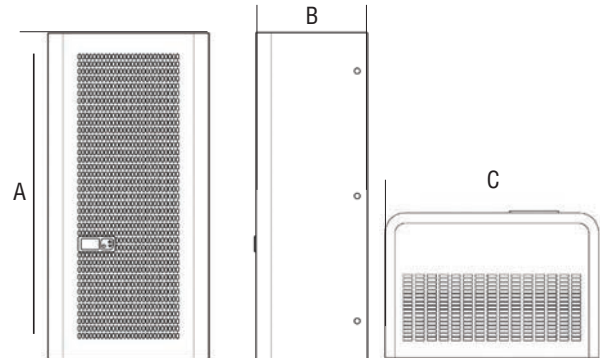

PANO ISITICILARI



MPHT MİNİ ISITICI

PHT PTC ISITICI

PFHT FANLI PTC ISITICI

PFHT FANLI ISITICI

AÇIKLAMA	BESLEME	KORUMA SINIFI	BAĞLANTI	KOD	FİYAT
15 W PTC PANO ISITICISI	100-250V AC-DC	IP20	KABLO	MPHT 15	22.00 \$
25 W PTC PANO ISITICISI	100-250V AC-DC	IP20	KABLO	MPHT 25	25.00 \$
30 W PTC PANO ISITICISI	100-250V AC-DC	IP20	KLEMENS	PHT 030	32.00 \$
50 W PTC PANO ISITICISI	100-250V AC-DC	IP20	KLEMENS	PHT 050	36.00 \$
75 W PTC PANO ISITICISI	100-250V AC-DC	IP20	KLEMENS	PHT 075	37.00 \$
100 W PTC PANO ISITICISI	100-250V AC-DC	IP20	KLEMENS	PHT 100	50.00 \$
150 W PTC PANO ISITICISI	100-250V AC-DC	IP20	KLEMENS	PHT 150	68.00 \$
100 W FANLI PTC PANO ISITICISI	230V AC 50/60 Hz	IP20	KLEMENS	PFHT 100	94.00 \$
150 W FANLI PTC PANO ISITICISI	230V AC 50/60 Hz	IP20	KLEMENS	PFHT 150	105.00 \$
250 W FANLI REZİSTANS PANO ISITICISI	230V AC 50/60 Hz	IP20	KLEMENS	PFHT 250	118.00 \$
500 W FANLI REZİSTANS PANO ISITICISI	230V AC 50/60 Hz	IP20	KLEMENS	PFHT 500	138.00 \$
750 W FANLI REZİSTANS PANO ISITICISI	230V AC 50/60 Hz	IP20	KLEMENS	PFHT 750	165.00 \$

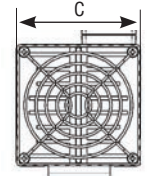
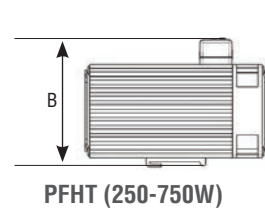
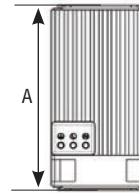
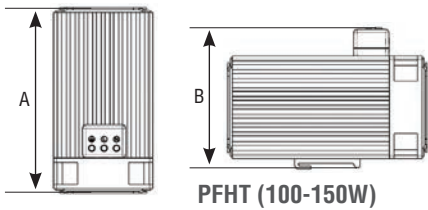
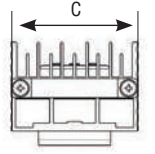
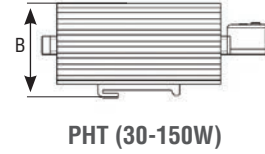
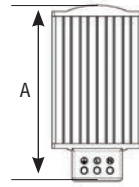
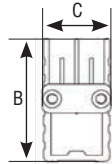
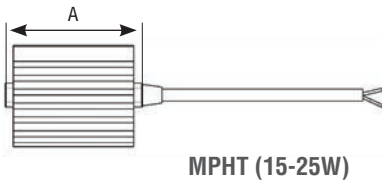

KOD	A (mm)	B (mm)	C (mm)	Ağırlık (gr)	KOD	A (mm)	B (mm)	C (mm)	Ağırlık (gr)
MPHT 15	60	50	27	110	PHT 150	228	70	59	640
MPHT 25	70	50	27	120	PFHT 100	170	89	60	700
PHT 030	128	70	59	340	PFHT 150	210	89	60	940
PHT 050	138	70	59	360	PFHT 250	152	110	80	1040
PHT 075	178	70	59	500	PFHT 500	182	110	80	1260
PHT 100	188	70	59	520	PFHT 750	232	110	80	1540

DAĞITICI ÜNİTELER

KOD	KUTUP SAYISI VE AKIM	DAĞITIM ÜNİTELERİ	ÖLÇÜ	ADET	B.FİYAT
PDB 207	2 Kutuplu 125 Amper	5*5,3+2*7,5 (2x7 Kutuplu)	65x45,5x51 mm	50	28.00 TL
PDB 211	2 Kutuplu 125 Amper	9*5,3+2*7,5 (2x11 Kutuplu)	100x45,5x51 mm	50	38.00 TL
PDB 215	2 Kutuplu 125 Amper	11*5,3+2*7,5+2*9.0 mm (2x15 Kutuplu)	132x45,5x51 mm	50	50.00 TL
PDB 407	4 Kutuplu 125 Amper	5*5,3+2*7,5 (4x7 Kutuplu)	65x89,5x50 mm	50	52.00 TL
PDB 411	4 Kutuplu 125 Amper	7*5,3+2*7,5+2*9.0 mm (4x11 Kutuplu)	100x89,5x50 mm	50	72.00 TL
PDB 415	4 Kutuplu 125 Amper	9*5,3+2*7,5+2*9.0 mm (4x15 Kutuplu)	132x89,5x51 mm	50	90.00 TL



PDB207



PDB211



PDB215



PDB407



PDB411

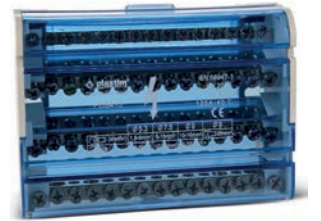

PDB415

SIKMALI KABLO PABUÇLARI



 **plastim**®

SKP SIKMALI KABLO PABUÇLARI



KOD	KABLOKESİTİ	CİVATA ÖLÇÜSÜ	D4	ET KALINLIĞI	A	D1	B	C1	C2	L	AMBALAJ MİKTARI	FİYAT
SKP10-5	10 mm	M5	6,2	0,75	13,3	4,7	10,5	7,2	8,8	29,8	800	0.98 TL
SKP16-6	16 mm	M6	7,9	0,75	18,5	6,4	11,8	7,1	7,5	33,5	500	1.14 TL
SKP25-8	25 mm	M8	9,0	0,85	22,1	7,3	13,2	7,8	9,0	38,6	300	1.63 TL
SKP35-8	35 mm	M8	10,8	1,15	25,5	8,5	15,5	9,3	9,6	44,5	200	2.85 TL
SKP35-10	35 mm	M10	10,8	1,15	25,5	8,5	15,5	9,3	9,6	44,5	200	2.85 TL
SKP50-10	50 mm	M10	12,6	1,30	28,6	10,0	18,2	10,8	12,1	51,5	150	4.06 TL
SKP70-10	70 mm	M10	14,5	1,50	34,5	11,5	21,0	10,8	10,0	55,0	100	5.85 TL
SKP95-10	95 mm	M10	16,5	1,50	37,0	13,5	24,2	10,85	12,0	60,0	80	8.05 TL
SKP95-12	95 mm	M12	16,5	1,50	37,0	13,5	24,2	10,85	12,0	60,0	80	8.05 TL
SKP120-12	120 mm	M12	19,1	1,80	43,0	15,5	28,0	13,9	13,2	70,0	50	10.90 TL
SKP150-12	150 mm	M12	20,6	1,80	43,2	17,0	30,2	16,3	16,0	75,5	30	12.20 TL
SKP185-16	185 mm	M16	22,6	1,90	47,3	18,8	33,5	17,0	18,6	83,0	30	14.30 TL
SKP240-16	240 mm	M16	25,2	2,00	54,7	21,2	37,5	17,35	18,2	90,0	25	21.80 TL

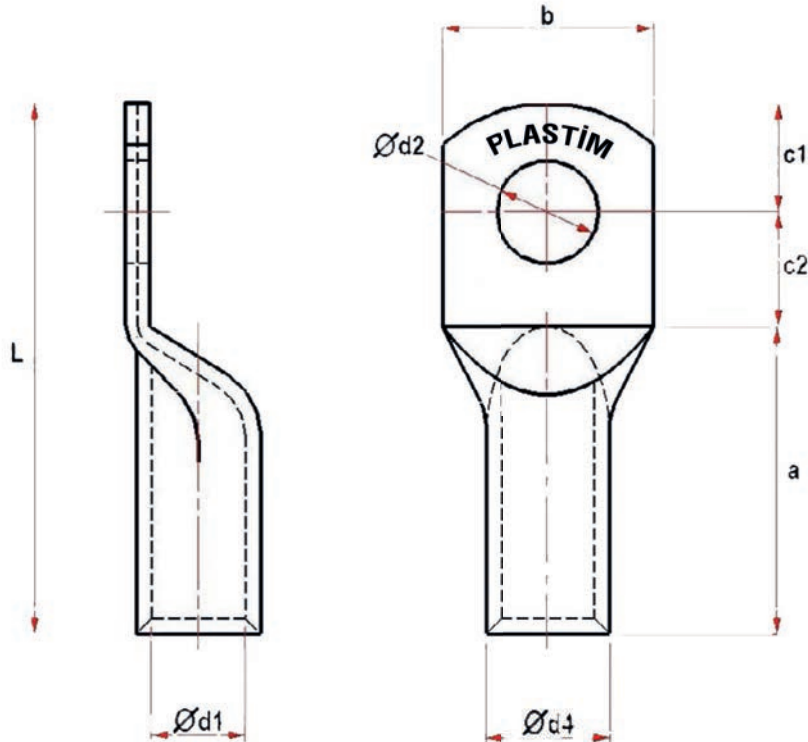

DIN RAYLARI VE RAY TAŐIYICI



KOD	ÖLÇÜ	TİP	UZUNLUK	AMBALAJ ADET	FİYAT
PDR1001	35x7.5mm	DÜZ	1mt	20	9.80 TL
PDR1002	35x7.5mm	DÜZ	2mt	20	19.50 TL
PDR2001	35x7.5mm	DELİKLİ	1mt	20	9.80 TL
PDR2002	35x7.5mm	DELİKLİ	2mt	20	19.50 TL

KOD	ÖLÇÜ	TİP	UZUNLUK	AMBALAJ ADET	FİYAT
PDR3001	35x15mm	DÜZ	1mt	10	24.50 TL
PDR3002	35x15mm	DÜZ	2mt	10	40.50 TL
PDR4001	35x15mm	DELİKLİ	1mt	10	24.50 TL
PDR4002	35x15mm	DELİKLİ	2mt	10	40.50 TL



KOD	AÇIKLAMA	AMBALAJ / ADET	FİYAT
PRT	Ray Taşıyıcı	25 Adet	4.00 TL

PET KABLO ÇORAPLARI

- Halogen free
- VW-1 Alev iletmez
- -60...+150C
- RoHS







KOD	AÇIKLAMA	RULO METRAJİ	FİYAT
PKC-03	PET Kablo Çorabı 3 mm Siyah	100m	0.22 \$
PKC-06	PET Kablo Çorabı 6 mm Siyah	100m	0.26 \$
PKC-08	PET Kablo Çorabı 8 mm Siyah	100m	0.36 \$
PKC-10	PET Kablo Çorabı 10 mm Siyah	100m	0.40 \$
PKC-12	PET Kablo Çorabı 12 mm Siyah	100m	0.50 \$
PKC-15	PET Kablo Çorabı 15 mm Siyah	100m	0.54 \$
PKC-20	PET Kablo Çorabı 20 mm Siyah	50m	0.72 \$
PKC-25	PET Kablo Çorabı 25 mm Siyah	50m	0.90 \$
PKC-30	PET Kablo Çorabı 30 mm Siyah	50m	1.20 \$
PKC-40	PET Kablo Çorabı 40 mm Siyah	50m	1.60 \$
PKC-50	PET Kablo Çorabı 50 mm Siyah	25m	2.10 \$

FİLTRELİ FANLAR



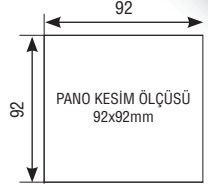

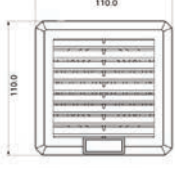

 **plastim**[®]

PFI SERİSİ KOLAY MONTAJLI FİLTRELER



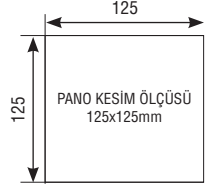



KOD	ÖLÇÜLER (mm)	RENK	KORUMA SINIFI	KOLİ ADEDİ
PFI 1000	110x110x20.5	RAL 7035 Gri	IP54	200

PFI 1000 - 110x110mm - IP54 **FİYAT: 3.25 \$**



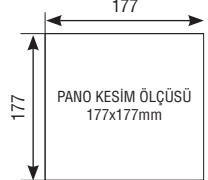



KOD	ÖLÇÜLER (mm)	RENK	KORUMA SINIFI	KOLİ ADEDİ
PFI 1500	160x160x31	RAL 7035 Gri	IP54	100

PFI 1500 - 160x160mm - IP54 **FİYAT: 4.50 \$**



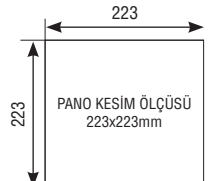

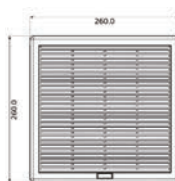

KOD	ÖLÇÜLER (mm)	RENK	KORUMA SINIFI	KOLİ ADEDİ
PFI 2000	210x210x31	RAL 7035 Gri	IP54	100

PFI 2000 - 210x210mm - IP54 **FİYAT: 7.00 \$**

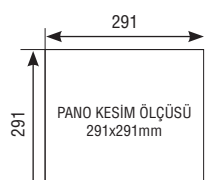

KOD	ÖLÇÜLER (mm)	RENK	KORUMA SINIFI	KOLİ ADEDİ
PFI 2500	260x260x31	RAL 7035 Gri	IP54	50

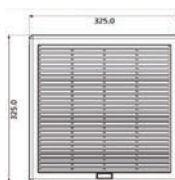
PFI 2500 - 260x260mm - IP54 **FİYAT: 8.25 \$**



KOD	ÖLÇÜLER (mm)	RENK	KORUMA SINIFI	KOLİ ADEDİ
PFI 3000	325x325x31	RAL 7035 Gri	IP54	30

PFI 3000 - 325x325mm - IP54 **FİYAT: 15.50 \$**



KLEMENS BAĞLANTILI FİLTRELİ FANLAR



PTF SERİSİ **KOLAY MONTAJLI** **plastim**® FİLTRELİ FANLAR

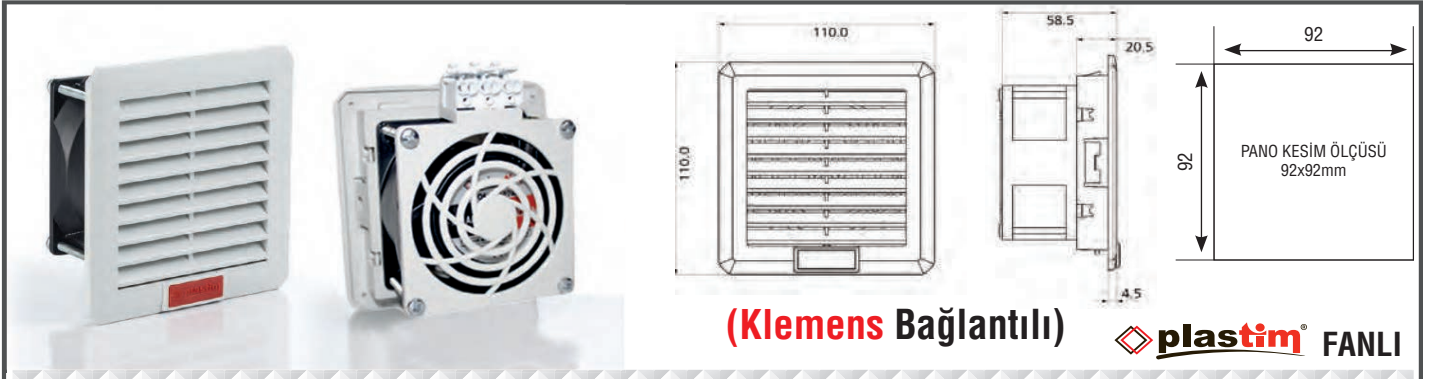

(Klemens Bağlantılı) **plastim**® FANLI

KOD	ÖLÇÜLER (mm)	FAN TİPİ	BESLEME (VAC)	GÜÇ (W)	HIZ (rpm)	FİLTRELİ (m ³ /h)	FİLTRESİZ (m ³ /h)	NOMİNAL AKIM (A)	GÜRÜLTÜ SEVİYESİ (db)
PTF 1000T	110x110x58.5	80x80x38 mm	230V-50/60Hz	14 (13)	2800	30	41	0.08 / 0.07	28 (31)

PTF 1000T - 30 m³/h - IP54 **FİYAT: 25.00 \$**

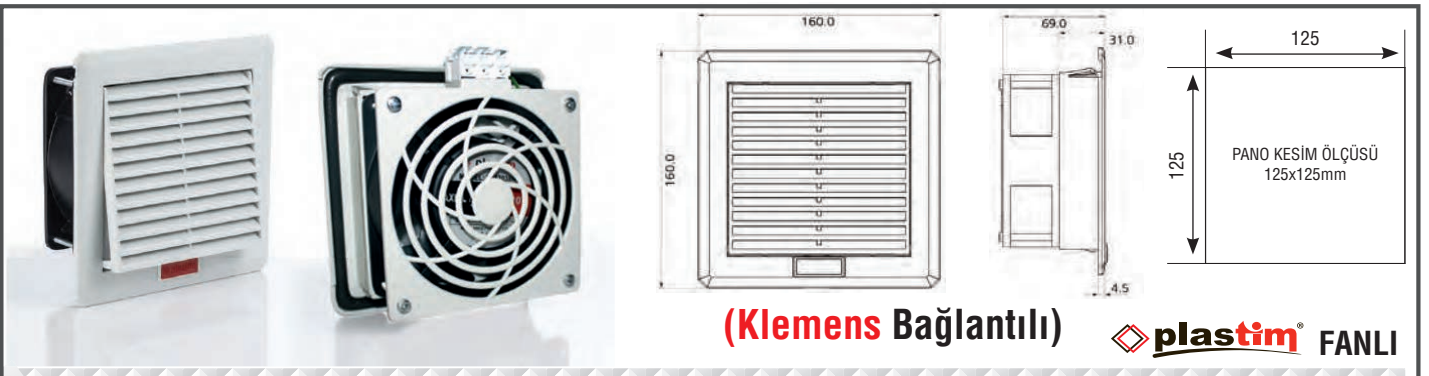

(Klemens Bağlantılı) **plastim**® FANLI

KOD	ÖLÇÜLER (mm)	FAN TİPİ	BESLEME (VAC)	GÜÇ (W)	HIZ (rpm)	FİLTRELİ (m ³ /h)	FİLTRESİZ (m ³ /h)	NOMİNAL AKIM (A)	GÜRÜLTÜ SEVİYESİ (db)
PTF 1500T	160x160x69	120x120x38 mm	230V-50/60Hz	26 (23)	2700	100	140	0.14 / 0.13	42 (46)

PTF 1500T - 100 m³/h - IP54 **FİYAT: 30.00 \$**

 **plastim**®

PTF SERİSİ KOLAY MONTAJLI plastim® FİLTRELİ FANLAR

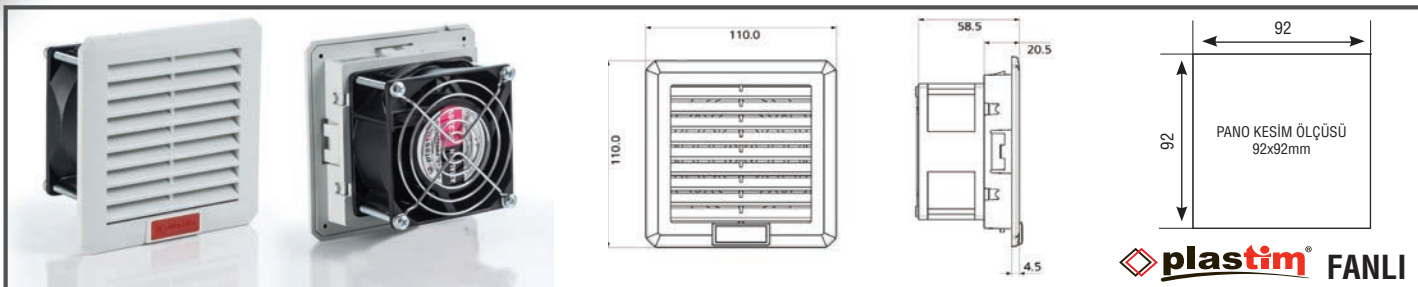

plastim® FANLI

KOD	ÖLÇÜLER (mm)	FAN TİPİ	BESLEME (VAC)	GÜÇ (W)	HIZ (rpm)	FİLTRELİ (m ³ /h)	FİLTRESİZ (m ³ /h)	NOMİNAL AKIM (A)	GÜRÜLTÜ SEVİYESİ (db)
PTF 1000	110x110x58.5	80x80x38 mm	230V-50/60Hz	14 (13)	2800	30	41	0.08 / 0.07	28 (31)

PTF 1000 - 30 m³/h - IP54

FİYAT: 18.00 \$

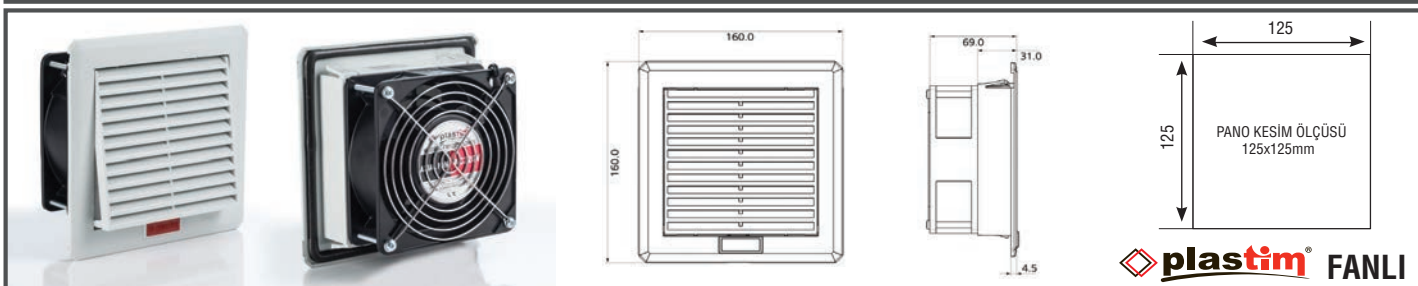

plastim® FANLI

KOD	ÖLÇÜLER (mm)	FAN TİPİ	BESLEME (VAC)	GÜÇ (W)	HIZ (rpm)	FİLTRELİ (m ³ /h)	FİLTRESİZ (m ³ /h)	NOMİNAL AKIM (A)	GÜRÜLTÜ SEVİYESİ (db)
PTF 1500	160x160x69	120x120x38 mm	230V-50/60Hz	26 (23)	2700	100	140	0.14 / 0.13	42 (46)

PTF 1500 - 100 m³/h - IP54

FİYAT: 25.00 \$

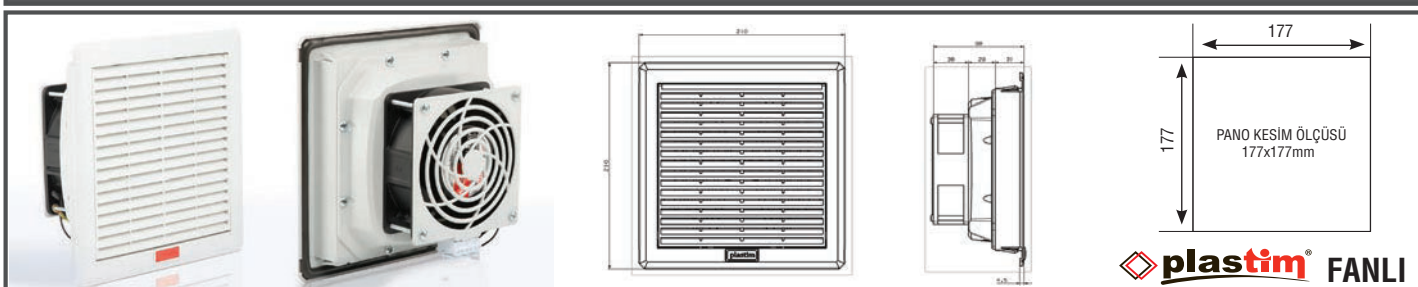

plastim® FANLI

KOD	ÖLÇÜLER (mm)	FAN TİPİ	BESLEME (VAC)	GÜÇ (W)	HIZ (rpm)	FİLTRELİ (m ³ /h)	FİLTRESİZ (m ³ /h)	NOMİNAL AKIM (A)	GÜRÜLTÜ SEVİYESİ (db)
PTF 2000	210x210x98	120x120x38 mm	230V-50/60Hz	26 (23)	2700	125	175	0.14 / 0.13	42 (46)

PTF 2000 - 125 m³/h - IP54

FİYAT: 32.00 \$

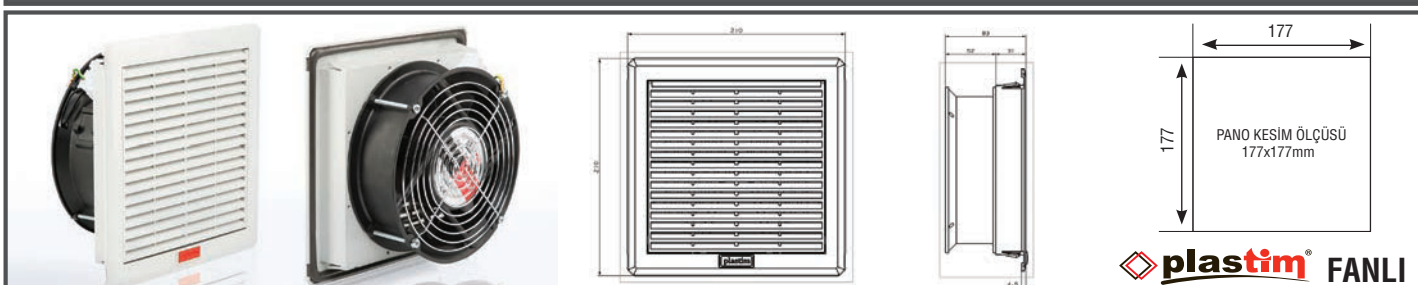

plastim® FANLI

KOD	ÖLÇÜLER (mm)	FAN TİPİ	BESLEME (VAC)	GÜÇ (W)	HIZ (rpm)	FİLTRELİ (m ³ /h)	FİLTRESİZ (m ³ /h)	NOMİNAL AKIM (A)	GÜRÜLTÜ SEVİYESİ (db)
PTF 3000	210x210x83	172x163x51mm	230V-50/60Hz	37 (35)	2400	175	245	0.23 / 0.22	52 (53)

PTF 3000 - 175 m³/h - IP54

FİYAT: 45.00 \$

PTF SERİSİ KOLAY MONTAJLI

plastim® FİLTRELİ FANLAR

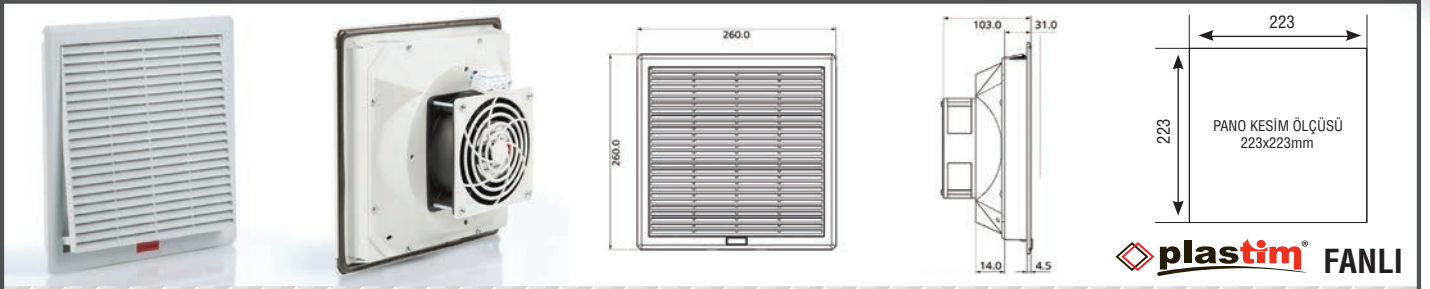

plastim® FANLI

KOD	ÖLÇÜLER (mm)	FAN TİPİ	BESLEME (VAC)	GÜÇ (W)	HIZ (rpm)	FİLTRELİ (m ³ /h)	FİLTRESİZ (m ³ /h)	NOMİNAL AKIM (A)	GÜRÜLTÜ SEVİYESİ (db)
PTF 2500	260x260x103	120x120x38 mm	230V-50/60Hz	26 (23)	2700	115	130	0.14 / 0.13	42 (46)

PTF 2500 - 115 m³/h - IP54

FİYAT: 35.00 \$

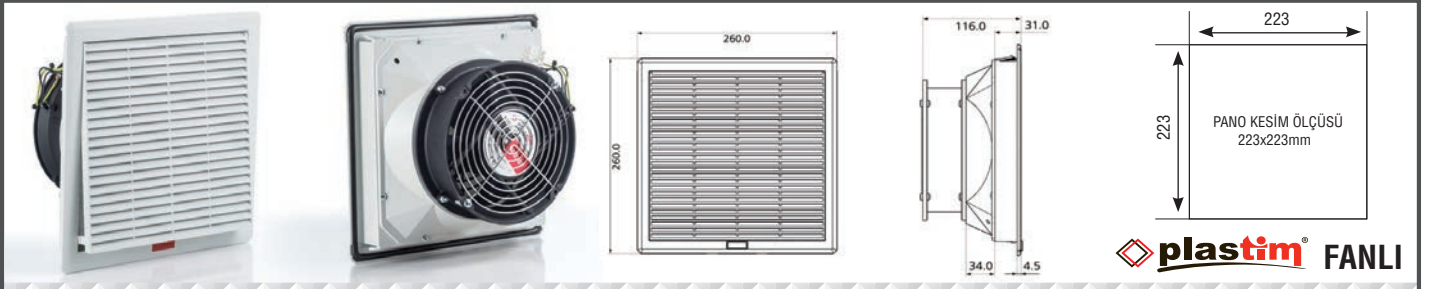

plastim® FANLI

KOD	ÖLÇÜLER (mm)	FAN TİPİ	BESLEME (VAC)	GÜÇ (W)	HIZ (rpm)	FİLTRELİ (m ³ /h)	FİLTRESİZ (m ³ /h)	NOMİNAL AKIM (A)	GÜRÜLTÜ SEVİYESİ (db)
PTF 3500	260x260x116	172x163x51 mm	230V-50/60Hz	37 (35)	2400	240	270	0.23 / 0.22	52 (53)

PTF 3500 - 240 m³/h - IP54

FİYAT: 55.00 \$

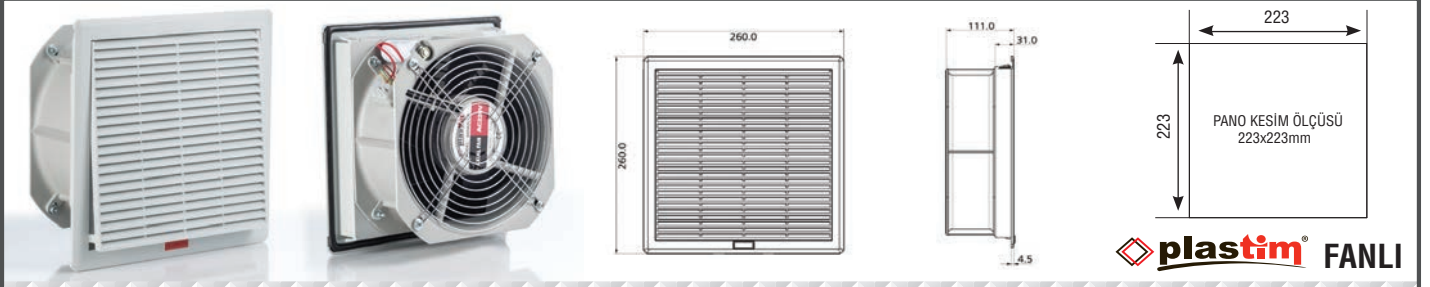

plastim® FANLI

KOD	ÖLÇÜLER (mm)	FAN TİPİ	BESLEME (VAC)	GÜÇ (W)	HIZ (rpm)	FİLTRELİ (m ³ /h)	FİLTRESİZ (m ³ /h)	NOMİNAL AKIM (A)	GÜRÜLTÜ SEVİYESİ (db)
PTF 4500	260x260x111	225x225x80 mm	230V-50/60Hz	66 (75)	2600	650	900	0.35 / 0.38	60 (63)

PTF 4500 - 650 m³/h - IP54

FİYAT: 115.00 \$

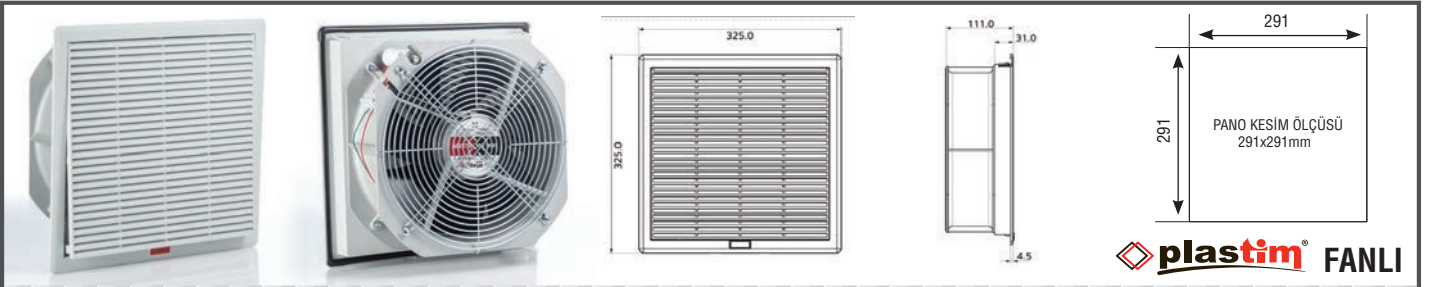

plastim® FANLI

KOD	ÖLÇÜLER (mm)	FAN TİPİ	BESLEME (VAC)	GÜÇ (W)	HIZ (rpm)	FİLTRELİ (m ³ /h)	FİLTRESİZ (m ³ /h)	NOMİNAL AKIM (A)	GÜRÜLTÜ SEVİYESİ (db)
PTF 5000	325x325x111	280x280x80 mm	230V-50/60Hz	110 (140)	2600	850	1200	0.50 / 0.72	65 (68)

PTF 5000 - 850 m³/h - IP54

FİYAT: 145.00 \$

PTF SERİSİ KOLAY MONTAJLI

plastim® 24v DC FİLTRELİ FANLAR

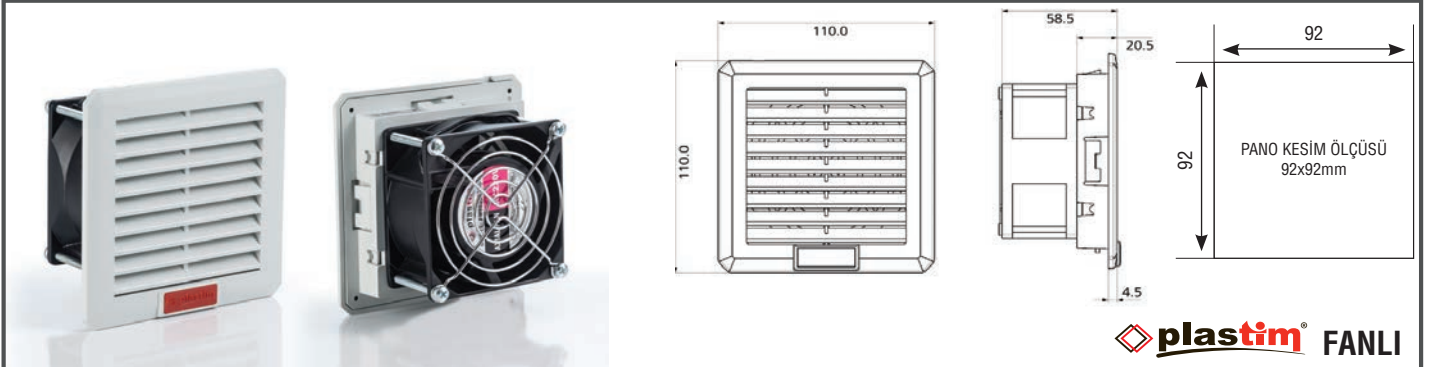

plastim® FANLI

KOD	ÖLÇÜLER (mm)	FAN TİPİ	BESLEME	GÜÇ (W)	HIZ (rpm)	FİLTRELİ (m³/h)	FİLTRESİZ (m³/h)	NOMİNAL AKIM (A)	GÜRÜLTÜ SEVİYESİ (db)
PTF 1000	110x110x58.5	80x80x38 mm	24v DC	14 (13)	2800	30	41	0.08 / 0.07	28 (31)

PTF 1000 24v DC - 30 m³/h - IP54

FİYAT: 25.00 \$

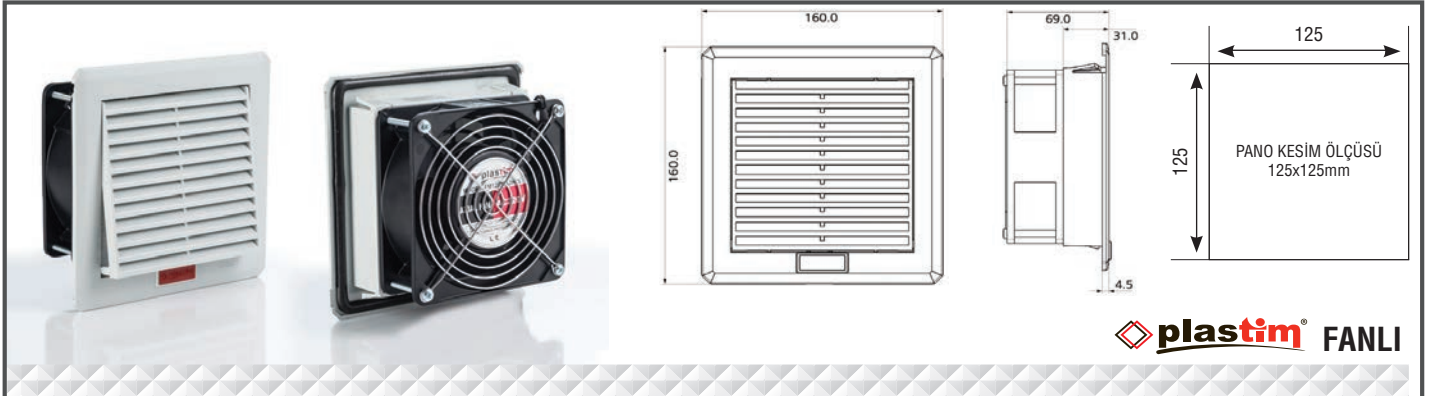

plastim® FANLI

KOD	ÖLÇÜLER (mm)	FAN TİPİ	BESLEME	GÜÇ (W)	HIZ (rpm)	FİLTRELİ (m³/h)	FİLTRESİZ (m³/h)	NOMİNAL AKIM (A)	GÜRÜLTÜ SEVİYESİ (db)
PTF 1500	160x160x69	120x120x38 mm	24v DC	26 (23)	2700	100	140	0.14 / 0.13	42 (46)

PTF 1500 24v DC - 100 m³/h - IP54

FİYAT: 30.00 \$

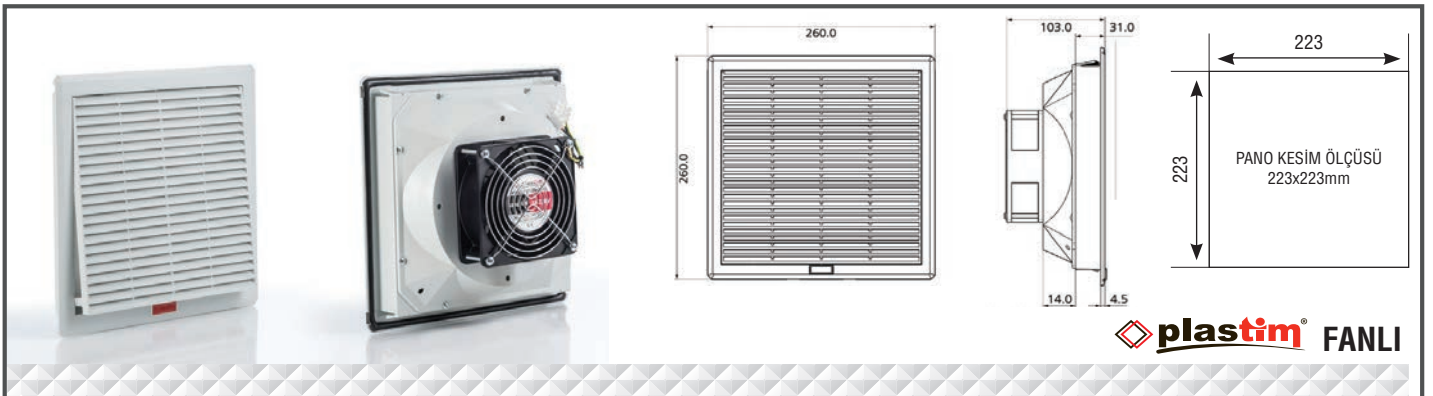

plastim® FANLI

KOD	ÖLÇÜLER (mm)	FAN TİPİ	BESLEME	GÜÇ (W)	HIZ (rpm)	FİLTRELİ (m³/h)	FİLTRESİZ (m³/h)	NOMİNAL AKIM (A)	GÜRÜLTÜ SEVİYESİ (db)
PTF 2500	260x260x103	120x120x38 mm	24v DC	26 (23)	2700	115	130	0.14 / 0.13	42 (46)

PTF 2500 24v DC - 115 m³/h - IP54

FİYAT: 45.00 \$

PTF SERİSİ KOLAY MONTAJLI

plastim® 24v DC FİLTRELİ FANLAR

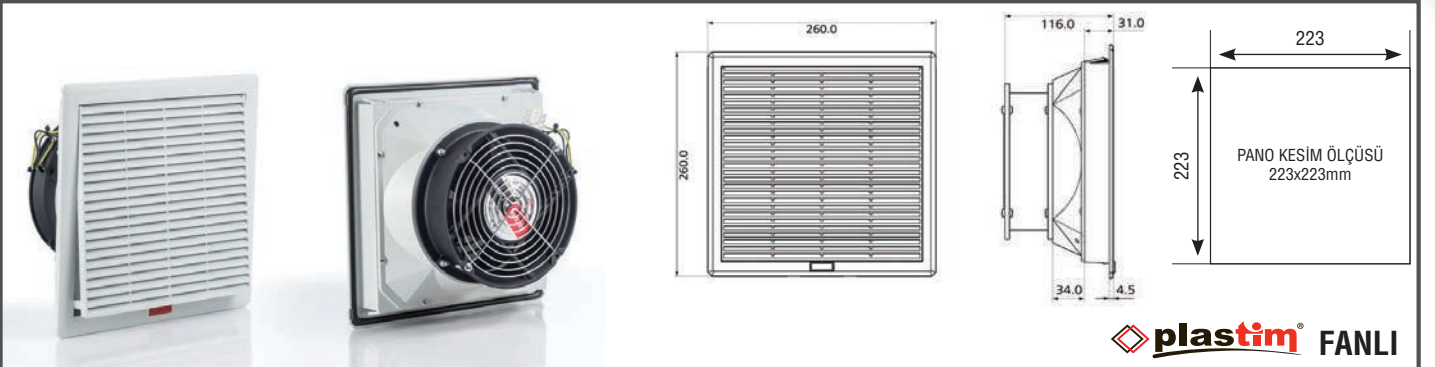

plastim® FANLI

KOD	ÖLÇÜLER (mm)	FAN TİPİ	BESLEME	GÜÇ (W)	HIZ (rpm)	FİLTRELİ (m ³ /h)	FİLTRESİZ (m ³ /h)	NOMİNAL AKIM (A)	GÜRÜLTÜ SEVİYESİ (db)
PTF 3500	260x260x116	172x163x51mm	24v DC	37 (35)	2400	240	270	0.23 / 0.22	52 (53)

PTF 3500 24v DC - 240 m³/h - IP54

FİYAT: 60.00 \$

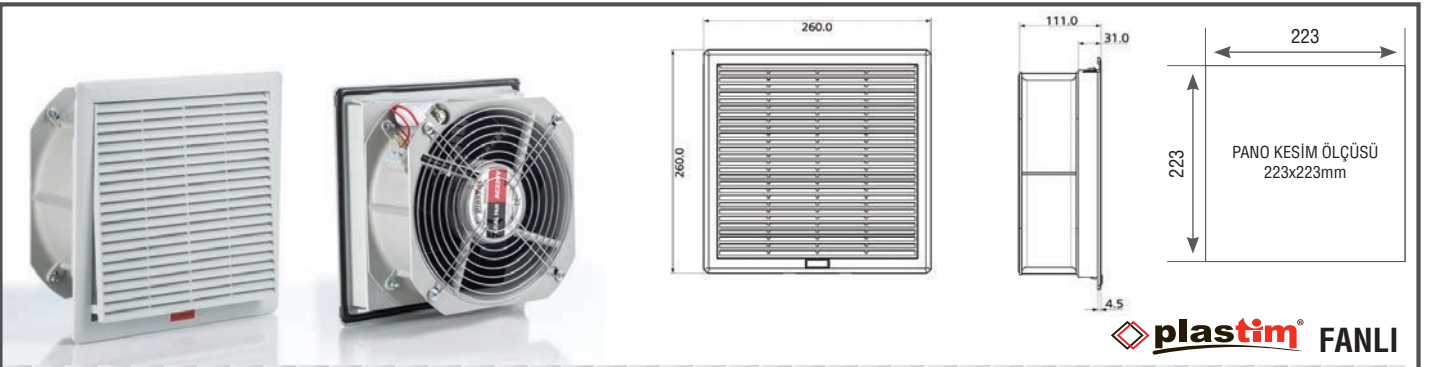

plastim® FANLI

KOD	ÖLÇÜLER (mm)	FAN TİPİ	BESLEME	GÜÇ (W)	HIZ (rpm)	FİLTRELİ (m ³ /h)	FİLTRESİZ (m ³ /h)	NOMİNAL AKIM (A)	GÜRÜLTÜ SEVİYESİ (db)
PTF 4500	260x260x111	225x225x80mm	24v DC	66 (75)	2600	650	900	0.35 / 0.38	60 (63)

PTF 4500 24v DC - 650 m³/h - IP54

FİYAT: 185.00 \$

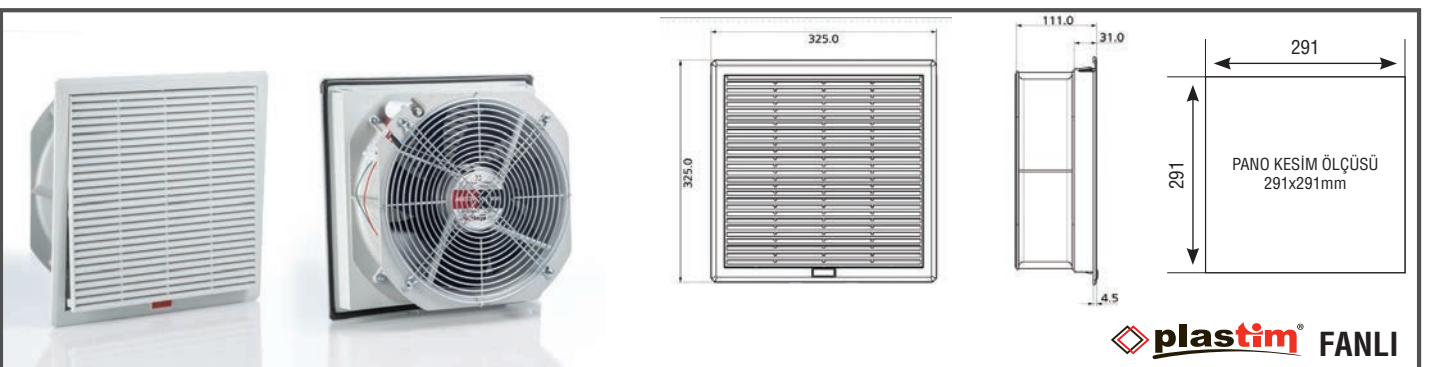

plastim® FANLI

KOD	ÖLÇÜLER (mm)	FAN TİPİ	BESLEME	GÜÇ (W)	HIZ (rpm)	FİLTRELİ (m ³ /h)	FİLTRESİZ (m ³ /h)	NOMİNAL AKIM (A)	GÜRÜLTÜ SEVİYESİ (db)
PTF 5000	325x325x111	280x280x80mm	24v DC	110 (140)	2600	850	1200	0.50 / 0.72	65 (68)

PTF 5000 24v DC - 850 m³/h - IP54

FİYAT: 198.00 \$

PTS SERİSİ KOLAY MONTAJLI FİLTRELİ FANLAR

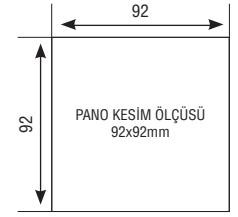
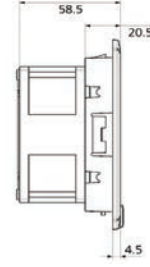
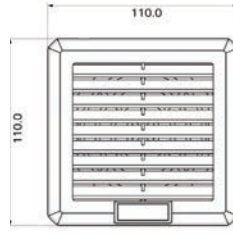

KOD	ÖLÇÜLER (mm)	FAN TİPİ	BESLEME (VAC)	GÜÇ (W)	HIZ (rpm)	FİLTRELİ (m³/h)	FİLTRESİZ (m³/h)	NOMİNAL AKIM (A)	GÜRÜLTÜ SEVİYESİ (db)
PTS 1000	110x110x58.5	80x80x38 mm	230V-50/60Hz	14 (13)	2800	30	41	0.08 / 0.07	28 (31)

PTS 1000 - 30 m³/h - IP54

FİYAT: 35.00 \$

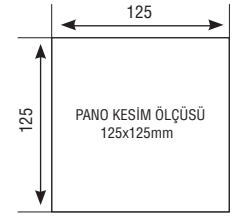
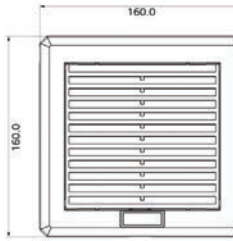

KOD	ÖLÇÜLER (mm)	FAN TİPİ	BESLEME (VAC)	GÜÇ (W)	HIZ (rpm)	FİLTRELİ (m³/h)	FİLTRESİZ (m³/h)	NOMİNAL AKIM (A)	GÜRÜLTÜ SEVİYESİ (db)
PTS 1500	160x160x69	120x120x38 mm	230V-50/60Hz	26 (23)	2700	100	140	0.14 / 0.13	42 (46)

PTS 1500 - 100 m³/h - IP54

FİYAT: 40.00 \$

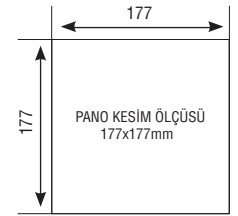
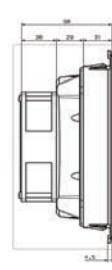
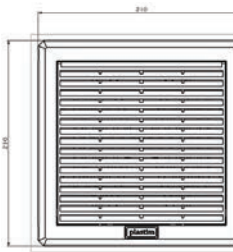

KOD	ÖLÇÜLER (mm)	FAN TİPİ	BESLEME (VAC)	GÜÇ (W)	HIZ (rpm)	FİLTRELİ (m³/h)	FİLTRESİZ (m³/h)	NOMİNAL AKIM (A)	GÜRÜLTÜ SEVİYESİ (db)
PTS 2000	160x160x69	120x120x38 mm	230V-50/60Hz	26 (23)	2700	125	175	0.14 / 0.13	42 (46)

PTS 2000 - 125 m³/h - IP54

FİYAT: 62.00 \$

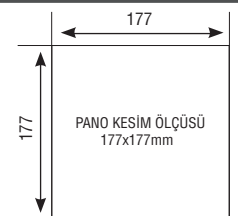
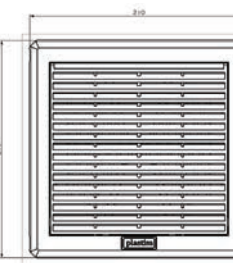

KOD	ÖLÇÜLER (mm)	FAN TİPİ	BESLEME (VAC)	GÜÇ (W)	HIZ (rpm)	FİLTRELİ (m³/h)	FİLTRESİZ (m³/h)	NOMİNAL AKIM (A)	GÜRÜLTÜ SEVİYESİ (db)
PTS 3000	160x160x69	120x120x38 mm	230V-50/60Hz	26 (23)	2700	175	245	0.14 / 0.13	42 (46)

PTS 3000 - 175 m³/h - IP54

FİYAT: 72.00 \$

PTS SERİSİ KOLAY MONTAJLI FİLTRELİ FANLAR

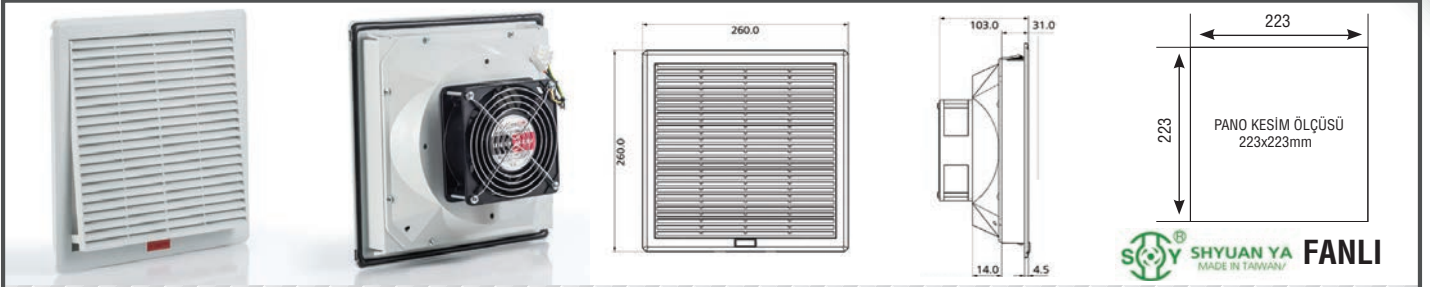

SHYUAN YA FANLI
MADE IN TAIWAN

KOD	ÖLÇÜLER (mm)	FAN TİPİ	BESLEME (VAC)	GÜÇ (W)	HIZ (rpm)	FİLTRELİ (m ³ /h)	FİLTRESİZ (m ³ /h)	NOMİNAL AKIM (A)	GÜRÜLTÜ SEVİYESİ (db)
PTS 2500	260x260x103	120x120x38 mm	230V-50/60Hz	26 (23)	2700	115	130	0.14 / 0.13	42 (46)

PTS 2500 - 115 m³/h - IP54

FİYAT: 65.00 \$

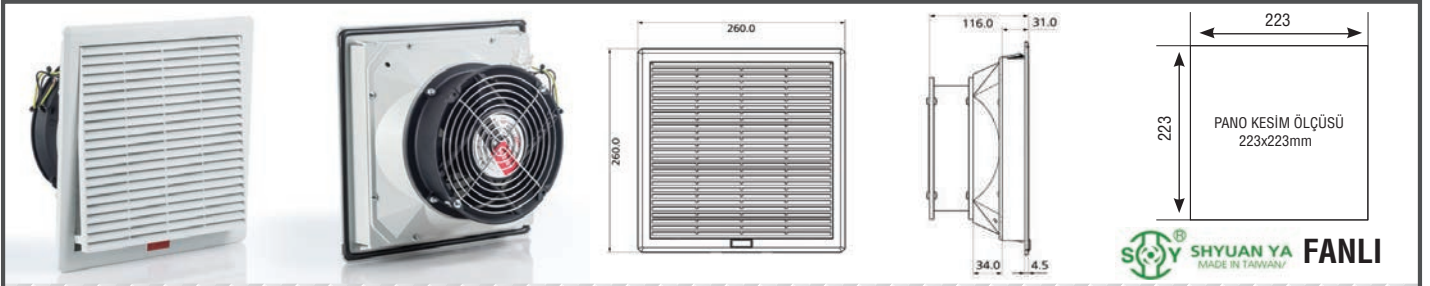

SHYUAN YA FANLI
MADE IN TAIWAN

KOD	ÖLÇÜLER (mm)	FAN TİPİ	BESLEME (VAC)	GÜÇ (W)	HIZ (rpm)	FİLTRELİ (m ³ /h)	FİLTRESİZ (m ³ /h)	NOMİNAL AKIM (A)	GÜRÜLTÜ SEVİYESİ (db)
PTS 3500	260x260x116	172x163x51 mm	230V-50/60Hz	37 (35)	2400	240	270	0.23 / 0.22	52 (53)

PTS 3500 - 240 m³/h - IP54

FİYAT: 70.00 \$

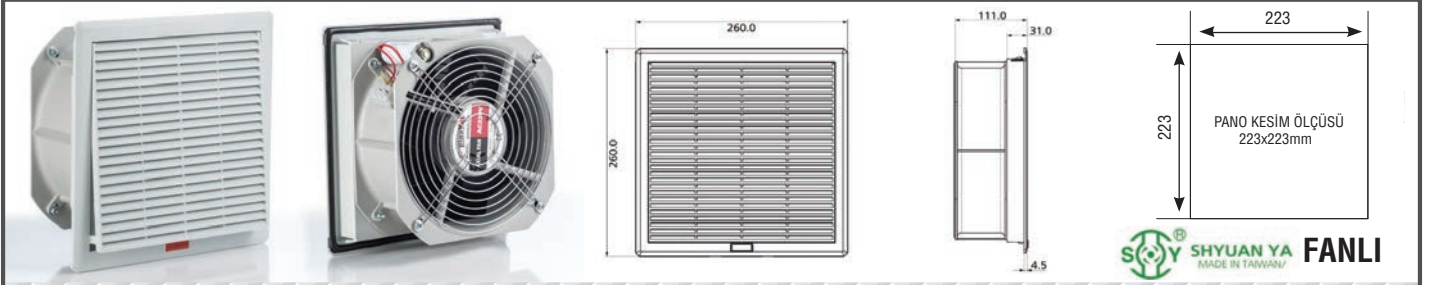

SHYUAN YA FANLI
MADE IN TAIWAN

KOD	ÖLÇÜLER (mm)	FAN TİPİ	BESLEME (VAC)	GÜÇ (W)	HIZ (rpm)	FİLTRELİ (m ³ /h)	FİLTRESİZ (m ³ /h)	NOMİNAL AKIM (A)	GÜRÜLTÜ SEVİYESİ (db)
PTS 4500	260x260x111	225x225x80 mm	230V-50/60Hz	66 (75)	2600	650	900	0.35 / 0.38	60 (63)

PTS 4500 - 650 m³/h - IP54

FİYAT: 160.00 \$

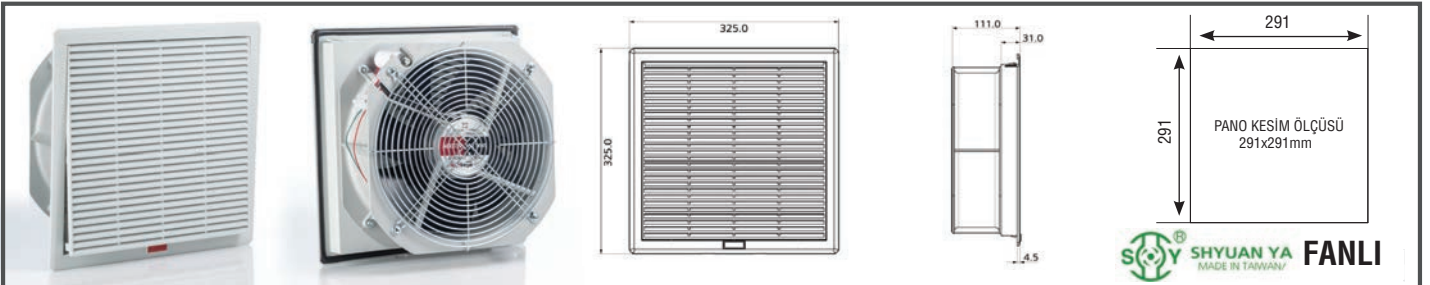

SHYUAN YA FANLI
MADE IN TAIWAN

KOD	ÖLÇÜLER (mm)	FAN TİPİ	BESLEME (VAC)	GÜÇ (W)	HIZ (rpm)	FİLTRELİ (m ³ /h)	FİLTRESİZ (m ³ /h)	NOMİNAL AKIM (A)	GÜRÜLTÜ SEVİYESİ (db)
PTS 5000	325x325x111	280x280x80 mm	230V-50/60Hz	110 (140)	2600	850	1200	0.50 / 0.72	65 (68)

PTS 5000 - 850 m³/h - IP54

FİYAT: 185.00 \$

ENDÜSTRİYEL FANLAR



ENDÜSTRİYEL FANLAR - DC BESLEME



80x80x25 mm
12VDC
Bilezikli

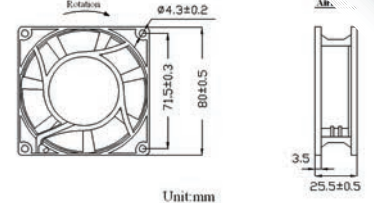

Unit:mm

KOD Birim	BESLEME V	FREKANS Hz	YATAKLAMA -	AKIM A	GÜÇ W	HIZ Rpm	KAPASİTE m³/h	GÜRÜLTÜ dB(A)	AĞIRLIK g
PF08025B12	12VDC	-	Bilezik	0.18	2.16	3000	66	36	80

PF08025B12 - AKSİYEL FAN

FİYAT: 3.50 \$



**Made in
Taiwan**

80x80x38 mm
24VDC
Bilezikli

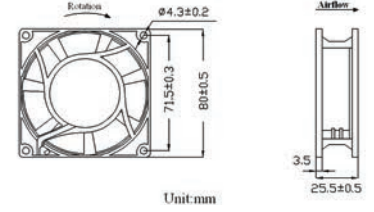

Unit:mm

KOD Birim	BESLEME V	FREKANS Hz	YATAKLAMA -	AKIM A	GÜÇ W	HIZ Rpm	KAPASİTE m³/h	GÜRÜLTÜ dB(A)	AĞIRLIK g
PF08038B24T	24VDC	-	Bilezik	0.18	2.16	3000	66	36	80

PF08038B24T - AKSİYEL FAN

FİYAT: 22.00 \$



120x120x38 mm
12VDC
Bilezikli

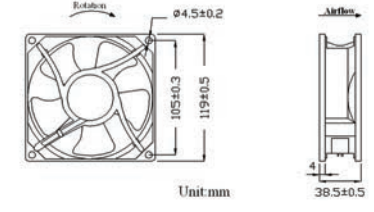

Unit:mm

KOD Birim	BESLEME V	FREKANS Hz	YATAKLAMA -	AKIM A	GÜÇ W	HIZ Rpm	KAPASİTE m³/h	GÜRÜLTÜ dB(A)	AĞIRLIK g
PF12038B12	12VDC	-	Bilezik	0.34	4.08	2500	162	40	250

PF12038B12 - AKSİYEL FAN

FİYAT: 12.00 \$



**Made in
Taiwan**

120x120x38 mm
24VDC
Bilezikli

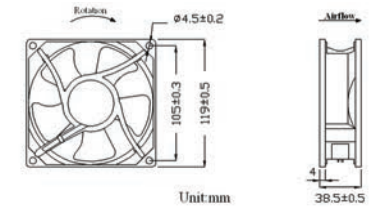

Unit:mm

KOD Birim	BESLEME V	FREKANS Hz	YATAKLAMA -	AKIM A	GÜÇ W	HIZ Rpm	KAPASİTE m³/h	GÜRÜLTÜ dB(A)	AĞIRLIK g
PF12038B24T	24VDC	-	Bilezik	0.20	4.80	2500	162	40	250

PF12038B24T - AKSİYEL FAN

FİYAT: 18.00 \$

ENDÜSTRİYEL FANLAR - DC BESLEME



120x120x38 mm
48VDC
Bilezikli

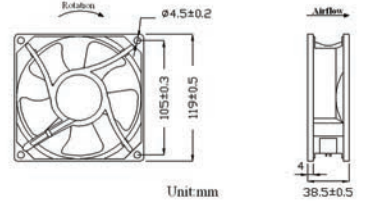

KOD Birim	BESLEME V	FREKANS Hz	YATAKLAMA -	AKIM A	GÜÇ W	HIZ Rpm	KAPASİTE m³/h	GÜRÜLTÜ dB(A)	AĞIRLIK g
PF12038B48	48VDC	-	Bilezik	0.18	8.64	2500	162	40	250

PF12038B48 - AKSİYEL FAN

FİYAT: 12.00 \$



172x150x51 mm
24VDC
Rulmanlı

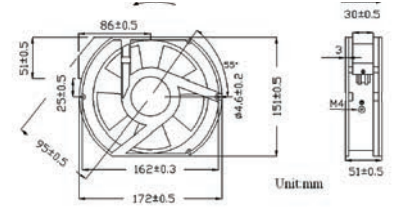

KOD Birim	BESLEME V	FREKANS Hz	YATAKLAMA -	AKIM A	GÜÇ W	HIZ Rpm	KAPASİTE m³/h	GÜRÜLTÜ dB(A)	AĞIRLIK g
PF17250R24	24VDC	-	Rulman	0.65	15.60	2400	272	47	800

PF17250R24 - AKSİYEL FAN

FİYAT: 22.00 \$



225x225x80 mm
24VDC
Rulmanlı

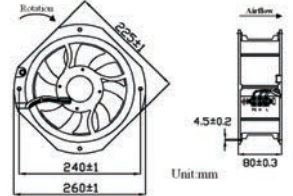

KOD Birim	BESLEME V	FREKANS Hz	YATAKLAMA -	AKIM A	GÜÇ W	HIZ Rpm	KAPASİTE m³/h	GÜRÜLTÜ dB(A)	AĞIRLIK g
PF22580R24	24VDC	-	Rulman	0.35	75	2600	1020	65	1920

PF22580R24 - AKSİYEL FAN

FİYAT: 154.00 \$



280x280x80 mm
24VDC
Rulmanlı

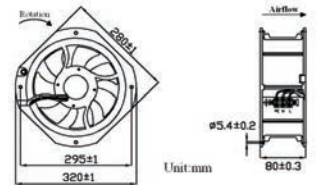

KOD Birim	BESLEME V	FREKANS Hz	YATAKLAMA -	AKIM A	GÜÇ W	HIZ Rpm	KAPASİTE m³/h	GÜRÜLTÜ dB(A)	AĞIRLIK g
PF28080R24	24VDC	-	Rulman	0.37	130	2600	1800/1980	68	2760

PF28080R24 - AKSİYEL FAN

FİYAT: 166.00 \$

ENDÜSTRİYEL FANLAR - 110V AC BESLEME



80x80x25 mm
110VAC 50/60 Hz
Bilezikli

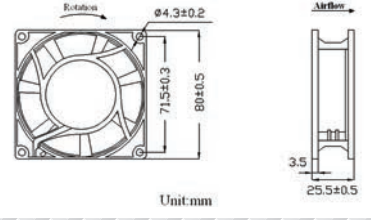

KOD Birim	BESLEME V	FREKANS Hz	YATAKLAMA -	AKIM A	GÜÇ W	HIZ Rpm	KAPASİTE m³/h	GÜRÜLTÜ dB(A)	AĞIRLIK g
PF8025B	110VAC	50/60	Bilezikli	0.13/0.12	13/12	2450	27/31	28/29	230

PF8025B - AKSİYEL FAN

FİYAT: 6.00 \$



120x120x38 mm
110VAC 50/60 Hz
Bilezikli

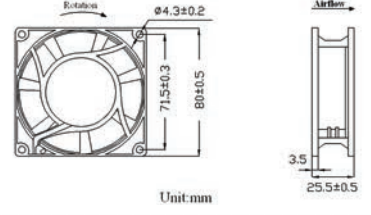

KOD Birim	BESLEME V	FREKANS Hz	YATAKLAMA -	AKIM A	GÜÇ W	HIZ Rpm	KAPASİTE m³/h	GÜRÜLTÜ dB(A)	AĞIRLIK g
PF12038B	110VAC	50/60	Bilezikli	0.24/0.23	26/23	2800	153/170	42/46	500

PF12038B - AKSİYEL FAN

FİYAT: 10.00 \$



225x225x80 mm
110VAC 50/60 Hz
Rulmanlı

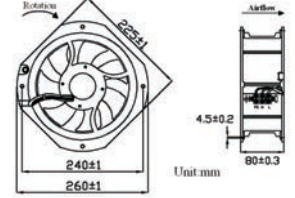

KOD Birim	BESLEME V	FREKANS Hz	YATAKLAMA -	AKIM A	GÜÇ W	HIZ Rpm	KAPASİTE m³/h	GÜRÜLTÜ dB(A)	AĞIRLIK g
PF22580R	110VAC	50/60	Rulman	0.35	75	2600	1020	65	1920

PF22580R - AKSİYEL FAN

FİYAT: 115.00 \$



280x280x80 mm
110VAC 50/60 Hz
Rulmanlı

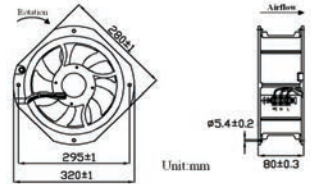

KOD Birim	BESLEME V	FREKANS Hz	YATAKLAMA -	AKIM A	GÜÇ W	HIZ Rpm	KAPASİTE m³/h	GÜRÜLTÜ dB(A)	AĞIRLIK g
PF28080R	110VAC	50/60	Rulman	0.37	130	2600	1800/1980	68	2760

PF28080R - AKSİYEL FAN

FİYAT: 150.00 \$

ENDÜSTRİYEL FANLAR 220V - AC BESLEME



80x80x25 mm
220VAC 50/60 Hz
Bilezikli

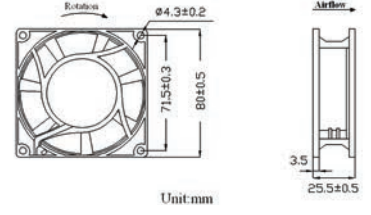

Unit:mm

KOD Birim	BESLEME V	FREKANS Hz	YATAKLAMA -	AKIM A	GÜÇ W	HIZ Rpm	KAPASİTE m³/h	GÜRÜLTÜ dB(A)	AĞIRLIK g
PF8025B	220VAC	50/60	Bilezikli	0.08/0.07	13/12	2450	27/31	28/29	230

PF8025B - AKSİYEL FAN

FİYAT: 6.00 \$



80x80x38 mm
220VAC 50/60 Hz
Bilezikli

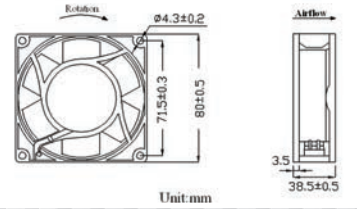

Unit:mm

KOD Birim	BESLEME V	FREKANS Hz	YATAKLAMA -	AKIM A	GÜÇ W	HIZ Rpm	KAPASİTE m³/h	GÜRÜLTÜ dB(A)	AĞIRLIK g
PF8038B	220VAC	50/60	Bilezikli	0.08/0.07	14/13	2400	44/51	28/31	340

PF8038B - AKSİYEL FAN

FİYAT: 6.00 \$



120x120x25 mm
220VAC 50/60 Hz
Bilezikli

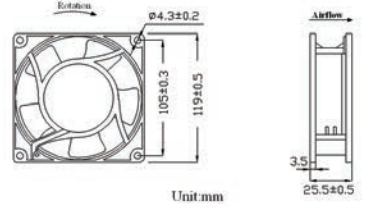

Unit:mm

KOD Birim	BESLEME V	FREKANS Hz	YATAKLAMA -	AKIM A	GÜÇ W	HIZ Rpm	KAPASİTE m³/h	GÜRÜLTÜ dB(A)	AĞIRLIK g
PF12025B	220VAC	50/60	Bilezikli	0.08/0.07	16/15	2400	72/77	40/41	380

PF12025B - AKSİYEL FAN

FİYAT: 6.00 \$



120x120x38 mm
220VAC 50/60 Hz
Bilezikli

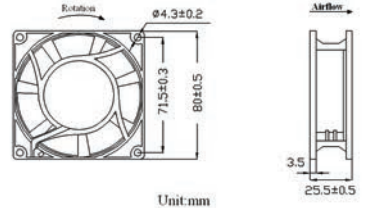

Unit:mm

KOD Birim	BESLEME V	FREKANS Hz	YATAKLAMA -	AKIM A	GÜÇ W	HIZ Rpm	KAPASİTE m³/h	GÜRÜLTÜ dB(A)	AĞIRLIK g
PF12038B	220VAC	50/60	Bilezikli	0.14/0.13	26/23	2700	153/170	42/46	500

PF12038B - AKSİYEL FAN

FİYAT: 6.00 \$

ENDÜSTRİYEL FANLAR 220V - AC BESLEME



120x120x38 mm
220VAC 50/60 Hz
Rulmanlı

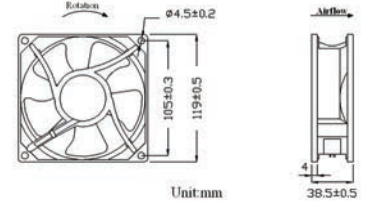

Unit:mm

38.5±0.5

KOD Birim	BESLEME V	FREKANS Hz	YATAKLAMA -	AKIM A	GÜÇ W	HIZ Rpm	KAPASİTE m³/h	GÜRÜLTÜ dB(A)	AĞIRLIK g
PF12038R	220VAC	50/60	Rulman	0.14/0.13	26/23	2700	153/170	42/46	50

PF12038R - AKSİYEL FAN

FİYAT: 11.00 \$



172x150x51 mm
220VAC 50/60 Hz
Rulmanlı

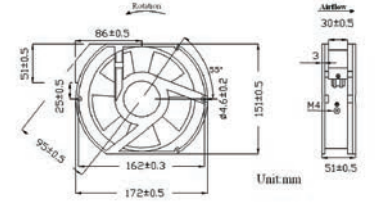

Unit:mm

51±0.5

KOD Birim	BESLEME V	FREKANS Hz	YATAKLAMA -	AKIM A	GÜÇ W	HIZ Rpm	KAPASİTE m³/h	GÜRÜLTÜ dB(A)	AĞIRLIK g
PF17250R	220VAC	50/60	Rulman	0.23/0.22	37/35	2500	255/289	52/53	950

PF17250R - AKSİYEL FAN

FİYAT: 20.00 \$



172x163x51 mm
220VAC 50/60 Hz
Rulmanlı

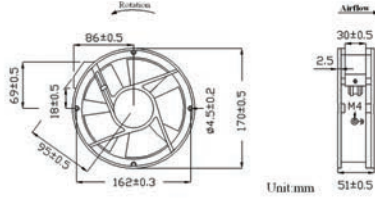

Unit:mm

51±0.5

KOD Birim	BESLEME V	FREKANS Hz	YATAKLAMA -	AKIM A	GÜÇ W	HIZ Rpm	KAPASİTE m³/h	GÜRÜLTÜ dB(A)	AĞIRLIK g
PF17260R	220VAC	50/60	Rulman	0.23/0.22	37/35	2400	255/289	52/53	950

PF17260R - AKSİYEL FAN

FİYAT: 20.00 \$



Ø220x60 mm
220VAC 50/60 Hz
Rulmanlı

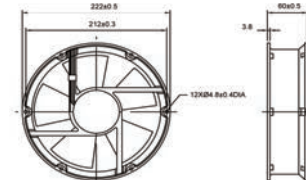

Unit:mm

60±0.5

KOD Birim	BESLEME V	FREKANS Hz	YATAKLAMA -	AKIM A	GÜÇ W	HIZ Rpm	KAPASİTE m³/h	GÜRÜLTÜ dB(A)	AĞIRLIK g
PF22060R	220VAC	50/60	Rulman	0.31/0.30	56/54	2100	290/305	64/66	1700

PF22060R - AKSİYEL FAN

FİYAT: 38.00 \$

ENDÜSTRİYEL FANLAR 220V - AC BESLEME



225x225x80 mm
220VAC 50/60 Hz
Rulmanlı

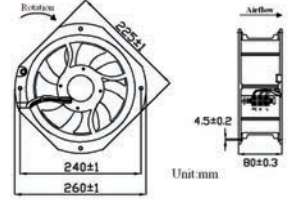

KOD Birim	BESLEME V	FREKANS Hz	YATAKLAMA -	AKIM A	GÜÇ W	HIZ Rpm	KAPASİTE m³/h	GÜRÜLTÜ dB(A)	AĞIRLIK g
PF22580R	220VAC	50/60	Rulman	0.35	75	2600	1020	65	1920

PF22580R - AKSİYEL FAN

FİYAT: 95.00 \$



280x280x80 mm
220VAC 50/60 Hz
Rulmanlı

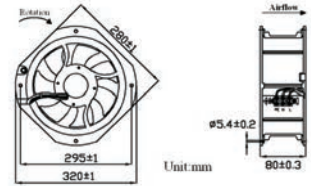

KOD Birim	BESLEME V	FREKANS Hz	YATAKLAMA -	AKIM A	GÜÇ W	HIZ Rpm	KAPASİTE m³/h	GÜRÜLTÜ dB(A)	AĞIRLIK g
PF28080R	220VAC	50/60	Rulman	0.37	130	2600	1800/1980	68	2760

PF28080R - AKSİYEL FAN

FİYAT: 125.00 \$





225x225x80 mm
220VAC 50/60 Hz
Rulmanlı

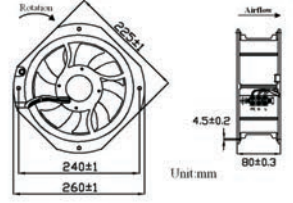

KOD Birim	BESLEME V	FREKANS Hz	YATAKLAMA -	AKIM A	GÜÇ W	HIZ Rpm	KAPASİTE m³/h	GÜRÜLTÜ dB(A)	AĞIRLIK g
AA2V200-80T	230VAC	50/60	Rulman	0.33	66	2600	1020	60	1920

PF22580R - AKSİYEL FAN

FİYAT: 115.00 \$



280x280x80 mm
220VAC 50/60 Hz
Rulmanlı

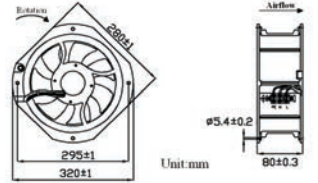

KOD Birim	BESLEME V	FREKANS Hz	YATAKLAMA -	AKIM A	GÜÇ W	HIZ Rpm	KAPASİTE m³/h	GÜRÜLTÜ dB(A)	AĞIRLIK g
AA2V250-80T	230VAC	50/60	Rulman	0.57	130	2600	1800/1980	68	2760

PF28080R - AKSİYEL FAN

FİYAT: 135.00 \$



Ø190x69 mm
220VAC 50/60 Hz
Rulmanlı

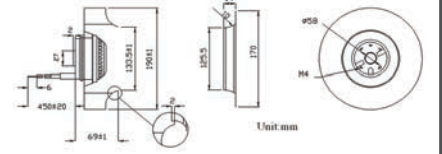

KOD Birim	BESLEME V	FREKANS Hz	YATAKLAMA -	AKIM A	GÜÇ W	HIZ Rpm	KAPASİTE m³/h	GÜRÜLTÜ dB(A)	AĞIRLIK g
BA2V190-69T	220VAC	50/60	Rulman	0.27/0.33	60/73	2600	582/642	63/66	1360

BA2V190-69T - RADYAL FAN

FİYAT: 80.00 \$



Ø220x71 mm
220VAC 50/60 Hz
Rulmanlı

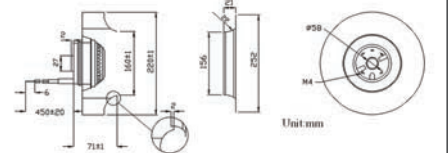

KOD Birim	BESLEME V	FREKANS Hz	YATAKLAMA -	AKIM A	GÜÇ W	HIZ Rpm	KAPASİTE m³/h	GÜRÜLTÜ dB(A)	AĞIRLIK g
BA2V220-71T	220VAC	50/60	Rulman	0.39/0.40	81/92	2600	980/1020	66/70	1410

BA2V220-71T - RADYAL FAN

FİYAT: 90.00 \$



60x60x30 mm
220VAC 50/60 Hz
Rulmanlı

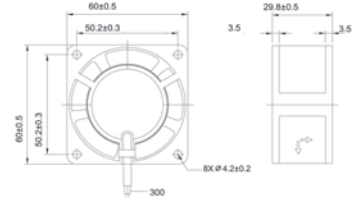

KOD Birim	BESLEME V	FREKANS Hz	YATAKLAMA -	AKIM A	GÜÇ W	HIZ Rpm	KAPASİTE m³/h	GÜRÜLTÜ dB(A)	AĞIRLIK g
A6030V2HBL	220VAC	50/60	Rulman	0.02/0.01	5/4	3000	14/16	27/28	140

A6030V2HBL - AKSİYEL FAN

FİYAT: 27.00 \$



120x120x38 mm
220VAC 50/60 Hz
Bilezikli

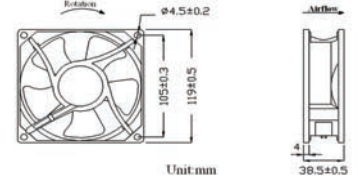

KOD Birim	BESLEME V	FREKANS Hz	YATAKLAMA -	AKIM A	GÜÇ W	HIZ Rpm	KAPASİTE m³/h	GÜRÜLTÜ dB(A)	AĞIRLIK g
A2V12C38T	220VAC	50/60	Bilezikli	0.13/0.10	20/16	2600	144/168	44/48	515

A2V12C38T - AKSİYEL FAN

FİYAT: 14.00 \$



172x150x51 mm
220VAC 50/60 Hz
Rulmanlı

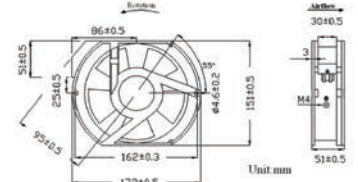

KOD Birim	BESLEME V	FREKANS Hz	YATAKLAMA -	AKIM A	GÜÇ W	HIZ Rpm	KAPASİTE m³/h	GÜRÜLTÜ dB(A)	AĞIRLIK g
A2V17C51T	220VAC	50/60	Rulman	0.11/0.15	25/32	2600	336/390	57/61	875

A2V17C51T - AKSİYEL FAN

FİYAT: 42.00 \$



172x150x55 mm
220VAC 50/60 Hz
Rulmanlı

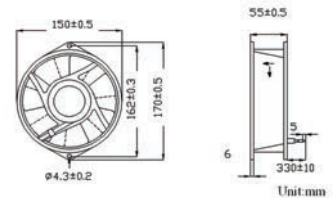

KOD Birim	BESLEME V	FREKANS Hz	YATAKLAMA -	AKIM A	GÜÇ W	HIZ Rpm	KAPASİTE m³/h	GÜRÜLTÜ dB(A)	AĞIRLIK g
A2V15C55T	220VAC	50/60	Rulman	0.17/0.19	37/43	3000	342/410	57/61	1000

A2V15C55T - AKSİYEL FAN

FİYAT: 68.00 \$

AKSESUARLAR

FAN TELLERİ

PT0808



PT1212



PT1717



PT2020

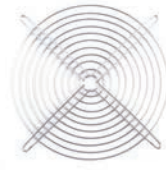

PT2525



KOD	AÇIKLAMA	PAKET ADEDİ	FİYAT
PT0606	METAL KORUMA TELİ 60x60mm için	100	0.50 \$
PT0808	METAL KORUMA TELİ 80x80mm için	100	0.50 \$
PT1212	METAL KORUMA TELİ 120x120mm için	100	0.80 \$
PT1717	METAL KORUMA TELİ 170x170mm için	100	1.00 \$
PT2020	METAL KORUMA TELİ 225x225mm için	100	2.50 \$
PT2525	METAL KORUMA TELİ 280x280mm için	100	8.00 \$



FİLTRE ÜNİTESİ

KOD	AÇIKLAMA	PAKET ADEDİ	FİYAT
PFM1000	FİLTRE ÜNİTESİ PFI 1000 için	10	26.00 TL
PFM1500	FİLTRE ÜNİTESİ PFI 1500 için	10	32.50 TL
PFM2500	FİLTRE ÜNİTESİ PFI 2500 için	10	76.00 TL
PFM3000	FİLTRE ÜNİTESİ PFI 3000 için	10	188.00 TL











PROJE CEPLERİ

AÇIKLAMA	PAKET ADEDİ	FİYAT
PPCA4 Proje Cebi A4	10	18.00 TL

AÇIKLAMA	PAKET ADEDİ	FİYAT
PPCA5 Proje Cebi A5	10	14.50 TL

İZOLELİ KABLO UÇLARI

İZOLELİ KABLO YÜKSÜKLERİ ALMAN NORMU

ÜRÜN KODU	RENK	KABLO KESİTİ	EBATLAR					KUTU ADETİ	LİSTE FİYATI
			[F]	[L]	[W]	[B]	[D]		
PKY-2005		0,50	8	14	2,6	6,0	1,3	1000	0.059 TL
PKY-2007		0,75	8	14	2,8	6,3	1,5	1000	0.059 TL
PKY-2010		1,00	8	14	3,0	6,3	1,7	1000	0.059 TL
PKY-2015		1,50	8	14	3,5	6,3	2,0	1000	0.059 TL
PKY-2025		2,50	8	14	4,2	7,4	2,5	500	0.065 TL
PKY-2040		4,00	10	17	4,8	7,4	3,2	500	0.117 TL
PKY-2060		6,00	12	20	6,3	8,5	3,9	250	0.150 TL
PKY-2100		10,00	12	22	7,6	8,8	4,9	100	0.182 TL
PKY-2160		16,00	12	24	8,8	10,0	6,2	100	0.260 TL
PKY-2250		25,00	16	28	11,2	12,0	7,7	50	0.475 TL
PKY-2350		35,00	16	30	12,7	14,0	8,7	50	0.605 TL
PKY-2500		50,00	20	36	15,0	16,0	10,9	25	0.962 TL







İZOLELİ KABLO YÜKSÜKLERİ FRANSIZ NORMU

ÜRÜN KODU	RENK	KABLO KESİTİ	EBATLAR					KUTU ADETİ	LİSTE FİYATI
			[F]	[L]	[W]	[B]	[D]		
PKY-3005		0,50	8	14	2,6	6,0	1,3	1000	0.059 TL
PKY-3007		0,75	8	14	2,8	6,3	1,5	1000	0.059 TL
PKY-3010		1,00	8	14	3,0	6,3	1,7	1000	0.059 TL
PKY-3015		1,50	8	14	3,5	6,3	2,0	1000	0.059 TL
PKY-3025		2,50	8	14	4,2	7,4	2,5	500	0.065 TL
PKY-3040		4,00	10	17	4,8	7,4	3,2	500	0.117 TL
PKY-3060		6,00	12	20	6,3	8,5	3,9	250	0.150 TL
PKY-3100		10,00	12	22	7,6	8,8	4,9	100	0.182 TL
PKY-3160		16,00	12	24	8,8	10,0	6,2	100	0.260 TL
PKY-3250		25,00	16	28	11,2	12,0	7,7	50	0.475 TL
PKY-3350		35,00	16	30	12,7	14,0	8,7	50	0.605 TL
PKY-3500		50,00	20	36	15,0	16,0	10,9	25	0.962 TL









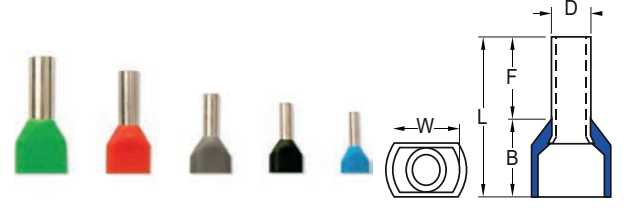

İZOLELİ KABLO UÇLARI

ÇİFT GİRİŞLİ İZOLELİ KABLO YÜKSÜKLERİ ALMAN NORMU

ÜRÜN KODU	RENK	KABLO KESİTİ	EBATLAR					KUTU ADETİ	LİSTE FİYATI
			[F]	[L]	[W]	[B]	[D]		
PKY-22005		2x0,50	8	14	5,0	6,5	1,8	1000	0.105 TL
PKY-22007		2x0,75	8	14	5,5	6,7	2,1	500	0.105 TL
PKY-22010		2x1,00	8	14	5,5	7,1	2,4	500	0.105 TL
PKY-22015		2x1,50	8	14	6,4	7,5	2,6	500	0.111 TL
PKY-22025		2x2,50	10	14	8,0	8,5	3,3	250	0.150 TL
PKY-22040		2x4,00	12	17	8,0	11,1	4,2	200	0.358 TL
PKY-22060		2x6,00	14	20	9,5	12,1	5,3	100	0.430 TL
PKY-22100		2x10,00	14	27	12,6	12,6	6,9	50	0.806 TL
PKY-22160		2x16,00	14	31	19,0	19,0	8,7	25	1.125 TL



ÇİFT GİRİŞLİ İZOLELİ KABLO YÜKSÜKLERİ FRANSIZ NORMU

ÜRÜN KODU	RENK	KABLO KESİTİ	EBATLAR					KUTU ADETİ	LİSTE FİYATI
			[F]	[L]	[W]	[B]	[D]		
PKY-23005		2x0,50	8	14	5,0	6,5	1,8	1000	0.105 TL
PKY-23007		2x0,75	8	14	5,5	6,7	2,1	500	0.105 TL
PKY-23010		2x1,00	8	14	5,5	7,1	2,4	500	0.105 TL
PKY-23015		2x1,50	8	14	6,4	7,5	2,6	500	0.111 TL
PKY-23025		2x2,50	10	14	8,0	8,5	3,3	250	0.150 TL
PKY-23040		2x4,00	12	17	8,0	11,1	4,2	200	0.358 TL
PKY-23060		2x6,00	14	20	9,5	12,1	5,3	100	0.430 TL
PKY-23100		2x10,00	14	27	12,6	12,6	6,9	50	0.806 TL
PKY-23160		2x16,00	14	31	19,0	19,0	8,7	25	1.125 TL

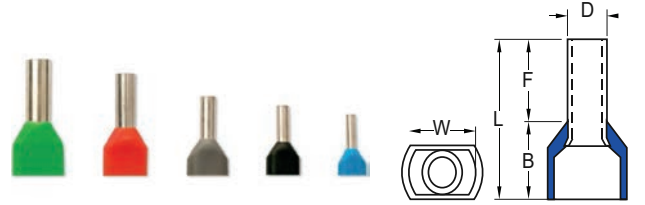

YUVARLAK TİP İZOLELİ KABLO UÇLARI

ÜRÜN KODU	KABLO KESİTİ	CİVATA ÖLÇÜSÜ	EBATLAR (mm)				KUTU ADETİ	LİSTE FİYATI
			[D2]	[I]	[D4]	[A]		
PYK-301	0,50-1,50mm	M3	3,2	16,0	4,0	10,0	200	0.137 TL
PYK-401	0,50-1,50mm	M4	4,3	17,0	4,0	10,0	200	0.189 TL
PYK-501	0,50-1,50mm	M5	5,3	18,0	4,0	10,0	200	0.202 TL
PYK-601	0,50-1,50mm	M6	6,5	18,0	4,0	10,0	200	0.255 TL
PYK-801	0,50-1,50mm	M8	8,4	22,0	4,0	10,0	200	0.275 TL



ÜRÜN KODU	KABLO KESİTİ	CİVATA ÖLÇÜSÜ	EBATLAR (mm)				KUTU ADETİ	LİSTE FİYATI
			[D2]	[I]	[D4]	[A]		
PYK-302	1,50-2,50mm	M3	3,2	16,0	4,5	10,0	200	0.195 TL
PYK-402	1,50-2,50mm	M4	4,3	17,0	4,5	10,0	200	0.221 TL
PYK-502	1,50-2,50mm	M5	5,3	19,0	4,5	10,0	200	0.247 TL
PYK-602	1,50-2,50mm	M6	6,5	21,0	4,5	10,0	200	0.280 TL
PYK-802	1,50-2,50mm	M8	8,4	22,0	4,5	10,0	200	0.306 TL
PYK-1002	1,50-2,50mm	M10	10,5	22,0	4,5	10,0	200	0.345 TL

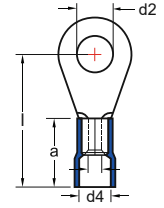

ÜRÜN KODU	KABLO KESİTİ	CİVATA ÖLÇÜSÜ	EBATLAR (mm)				KUTU ADETİ	LİSTE FİYATI
			[D2]	[I]	[D4]	[A]		
PYK-406	4,00-6,00mm	M4	4,3	21,0	6,3	13,0	100	0.403 TL
PYK-506	4,00-6,00mm	M5	5,3	22,0	6,3	13,0	100	0.410 TL
PYK-606	4,00-6,00mm	M6	6,5	22,5	6,3	13,0	100	0.475 TL
PYK-806	4,00-6,00mm	M8	8,4	26,0	6,3	13,0	100	0.592 TL
PYK-1006	4,00-6,00mm	M10	10,5	28,0	6,3	13,0	100	0.605 TL
PYK-1206	4,00-6,00mm	M12	13,0	28,0	6,3	13,0	100	0.715 TL

İZOLELİ KABLO UÇLARI

ÇATAL TİP İZOLELİ KABLO UÇLARI

ÜRÜN KODU	KABLO KESİTİ	ÇİVATA ÖLÇÜSÜ	EBATLAR (mm)				KUTU ADETİ	LİSTE FİYATI
			[D2]	[I]	[D4]	[A]		
PCK-301	0,50-1,50mm	M3	3,2	16,0	4,0	10,0	200	0.163 TL
PCK-401	0,50-1,50mm	M4	4,3	17,0	4,0	10,0	200	0.182 TL
PCK-501	0,50-1,50mm	M5	5,3	18,0	4,0	10,0	200	0.202 TL
PCK-601	0,50-1,50mm	M6	6,5	20,0	4,0	10,0	200	0.234 TL



ÜRÜN KODU	KABLO KESİTİ	ÇİVATA ÖLÇÜSÜ	EBATLAR (mm)				KUTU ADETİ	LİSTE FİYATI
			[D2]	[I]	[D4]	[A]		
PCK-302	1,50-2,50mm	M3	3,2	18,0	4,5	10,0	200	0.189 TL
PCK-402	1,50-2,50mm	M4	4,3	17,0	4,5	10,0	200	0.202 TL
PCK-502	1,50-2,50mm	M5	5,3	19,0	4,5	10,0	200	0.228 TL
PCK-602	1,50-2,50mm	M6	6,5	21,0	4,5	10,0	200	0.267 TL

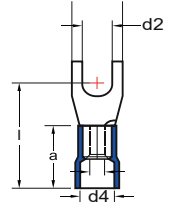

ÜRÜN KODU	KABLO KESİTİ	ÇİVATA ÖLÇÜSÜ	EBATLAR (mm)				KUTU ADETİ	LİSTE FİYATI
			[D2]	[I]	[D4]	[A]		
PCK-406	4,00-6,00mm	M4	8,4	22,0	4,5	10,0	100	0.364 TL
PCK-506	4,00-6,00mm	M5	10,5	22,0	4,5	10,0	100	0.370 TL
PCK-606	4,00-6,00mm	M6	13,0	25,0	4,5	10,0	100	0.468 TL
PCK-806	4,00-6,00mm	M8	4,0	21,0	6,3	13,0	100	0.618 TL



DİŞİ FASTON TİP İZOLELİ KABLO UÇLARI

ÜRÜN KODU	KABLO KESİTİ	SOKET GENİŞLİĞİ	EBATLAR (mm)					KUTU ADETİ	LİSTE FİYATI
			[W]	[F]	[L]	[E]	[D]		
PFD-1288	0,50-1,50mm	0,8x2,80	3,2	6,5	19,0	10,5	3,8	200	0.234 TL
PFD-1488	0,50-1,50mm	0,8x4,75	5	6,4	19,4	10,5	3,8	200	0.260 TL
PFD-1638	0,50-1,50mm	0,8x6,35	6,6	7,5	20,8	10,5	3,8	200	0.338 TL
PFD-2488	1,50-2,50mm	0,8x4,75	5	6,4	19,4	10,5	4,7	200	0.338 TL
PFD-2638	1,50-2,50mm	0,8x6,35	6,6	7,5	20,8	10,5	4,7	200	0.351 TL
PFD-5638	4,00-6,00mm	0,8x6,35	6,6	7,5	23,3	13,0	6,2	100	0.468 TL

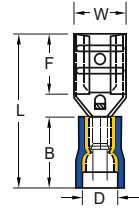

DİŞİ FASTON TİP TAM İZOLELİ KABLO UÇLARI

ÜRÜN KODU	KABLO KESİTİ	SOKET GENİŞLİĞİ	EBATLAR (mm)					KUTU ADETİ	LİSTE FİYATI
			[W]	[F]	[L]	[E]	[D]		
İPFD-1288	0,50-1,50mm	0,8x2,80	3,2	6,5	19,0	10,5	3,8	200	0.345 TL
İPFD-1488	0,50-1,50mm	0,8x4,75	5	6,4	19,4	10,5	3,8	200	0.345 TL
İPFD-1638	0,50-1,50mm	0,8x6,35	6,6	7,5	20,8	10,5	3,8	200	0.436 TL
İPFD-2488	1,50-2,50mm	0,8x4,75	5	6,4	19,4	10,5	4,7	200	0.371 TL
İPFD-2638	1,50-2,50mm	0,8x6,35	6,6	7,5	20,8	10,5	4,7	200	0.468 TL
İPFD-5638	4,00-6,00mm	0,8x6,35	6,6	7,5	23,3	13,0	6,2	100	0.546 TL

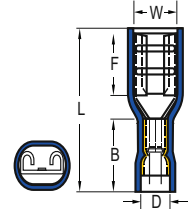

ERKEK FASTON TİP İZOLELİ KABLO UÇLARI

ÜRÜN KODU	KABLO KESİTİ	SOKET GENİŞLİĞİ	EBATLAR (mm)					KUTU ADETİ	LİSTE FİYATI
			[W]	[F]	[L]	[E]	[D]		
PFE-1288	0,50-1,50mm	0,8x2,80	2,8	6,5	19,2	10,5	3,8	200	0.260 TL
PFE-1488	0,50-1,50mm	0,8x4,75	4,8	6,7	19,8	10,5	3,8	200	0.260 TL
PFE-1638	0,50-1,50mm	0,8x6,35	6,35	7,7	21,8	10,5	3,8	200	0.300 TL
PFE-2488	1,50-2,50mm	0,8x4,75	4,8	6,7	19,8	10,5	4,7	200	0.260 TL
PFE-2638	1,50-2,50mm	0,8x6,35	6,35	7,7	21,8	10,5	4,7	200	0.300 TL
PFE-5638	4,00-6,00mm	0,8x6,35	6,35	7,7	24,0	13,0	6,2	100	0.423 TL

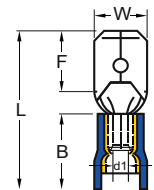

İZOLELİ KABLO UÇLARI

DİŞİ TERMİNALLER İZOLELİ KABLO UÇLARI

ÜRÜN KODU	KABLO KESİTİ	EBATLAR (mm)					KUTU ADETİ	LİSTE FİYATI
		[W]	[F]	[L]	[E]	[D]		
PFT-1040	0,50-1,50mm	3,9	7,0	23,3	10,5	3,8	200	0.533 TL
PFT-2050	1,50-2,50mm	4,9	7,0	23,3	10,5	4,7	100	0.605 TL
PFT-5050	4,00-6,00mm	4,9	7,0	25,1	12,5	6,2	100	0.813 TL

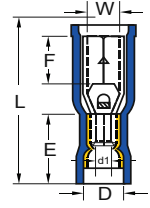

ERKEK TERMİNALLER İZOLELİ KABLO UÇLARI

ÜRÜN KODU	KABLO KESİTİ	EBATLAR (mm)					KUTU ADETİ	LİSTE FİYATI
		[W]	[F]	[L]	[E]	[D]		
PMT-1040	0,50-1,50mm	4,0	8,5	21,5	10,5	3,8	200	0.455 TL
PMT-2050	1,50-2,50mm	5,0	8,5	21,2	10,5	4,7	100	0.546 TL
PMT-5050	4,00-6,00mm	5,0	8,5	24,0	13,0	6,2	100	0.813 TL

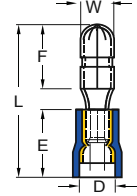

İĞNE TİP İZOLELİ KABLO UÇLARI

ÜRÜN KODU	KABLO KESİTİ	EBATLAR (mm)					KUTU ADETİ	LİSTE FİYATI
		[W]	[F]	[L]	[E]	[D]		
PKI-101	0,50-1,50mm	1,9	10,0	19,0	10,0	4,0	200	0.202 TL
PKI-102	1,50-2,50mm	1,9	12,0	21,8	10,0	4,5	200	0.208 TL
PKI-106	4,00-6,00mm	2,8	14,0	27,0	27,0	6,4	100	0.480 TL

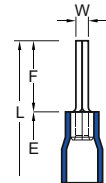

PBO SERİSİ BUTON VE AKSESUARLARI



 **plastim**[®]

PB0 SERİSİ 22mm BUTON VE SİNYALLER



KOD	RENK	AÇIKLAMA	KONTAK	FİYAT
PB0-AA31	Yeşil	Normal Buton Yeşil	1NO	12.50 TL
PB0-AA42	Kırmızı	Normal Buton Kırmızı	1NC	12.50 TL
PB0-AA51	Sarı	Normal Buton Sarı	1NO	12.50 TL
PB0-AA61	Mavi	Normal Buton Mavi	1NO	12.50 TL
PB0-AA11	Beyaz	Normal Buton Beyaz	1NO	12.50 TL
PB0-AA21	Siyah	Normal Buton Siyah	1NO	12.50 TL
PB0-AA3341	Beyaz	Oklu Buton Beyaz →	1NO	14.00 TL
PB0-AA3351	Siyah	Oklu Buton Siyah →	1NO	14.00 TL
PB0-AA51L	Sarı	Normal Buton Sarı Lamba İşaretli ☀	1NO	14.00 TL
PB0-AW31B5	Beyaz	Işıklı Buton Beyaz LED 24V	1NO	25.00 TL
PB0-AW33B5	Yeşil	Işıklı Buton Yeşil LED 24V	1NO	25.00 TL
PB0-AW34B5	Kırmızı	Işıklı Buton Kırmızı LED 24V	1NC	25.00 TL
PB0-AW35B5	Sarı	Işıklı Buton Sarı LED 24V	1NO	25.00 TL
PB0-AW36B5	Mavi	Işıklı Buton Mavi LED 24V	1NO	25.00 TL
PB0-AW31M5	Beyaz	Işıklı Buton Beyaz LED 220V	1NO	25.00 TL
PB0-AW33M5	Yeşil	Işıklı Buton Yeşil LED 220V	1NO	25.00 TL
PB0-AW34M5	Kırmızı	Işıklı Buton Kırmızı LED 220V	1NC	25.00 TL
PB0-AW35M5	Sarı	Işıklı Buton Sarı LED 220V	1NO	25.00 TL
PB0-AW36M5	Mavi	Işıklı Buton Mavi LED 220V	1NO	25.00 TL
PB0-AC42	Kırmızı	Yaylı Mantar Buton Kırmızı	1NC	14.00 TL
PB0-AC31	Yeşil	Yaylı Mantar Buton Yeşil	1NO	14.00 TL
PB0-AS542	Kırmızı	Acil Stop Butonu	1NC	28.00 TL
PB0-AS542-24L	Kırmızı	Acil Stop Butonu 24V LED	1NC	43.00 TL
PB0-AS542-230L	Kırmızı	Acil Stop Butonu 220V LED	1NC	43.00 TL





















PB0 SERİSİ 22mm BUTON VE SİNYALLER



KOD	RENK	AÇIKLAMA	KONTAK	FİYAT
PB0-AD21	Siyah	Kalıcı Mandal Buton 0-1 Siyah	1NO	13.50 TL
PB0-AD33	Siyah	Kalıcı Mandal Buton 1-0-2 Siyah	2NO	19.00 TL
PB0-AD53	Siyah	Yaylı Mandal Buton 1-0-2 Siyah	2NO	22.00 TL
PB0-AD41	Siyah	Yaylı Mandal Buton 0-1 Siyah	1NO	16.00 TL
PB0-AJ21	Siyah	Kalıcı Mandal Buton 0-1 Siyah Uzun Mandal	1NO	14.50 TL
PB0-AJ33	Siyah	Kalıcı Mandal Buton 1-0-2 Siyah Uzun Mandal	2NO	20.00 TL
PB0-AJ53	Siyah	Yaylı Mandal Buton 1-0-2 Siyah Uzun Mandal	2NO	23.00 TL
PB0-AK123B5	Yeşil	Işıklı Mandal Buton 0-1 Yeşil LED 24V	1NO	30.00 TL
PB0-AK124B5	Kırmızı	Işıklı Mandal Buton 0-1 Kırmızı LED 24V	1NC	30.00 TL
PB0-AK125B5	Sarı	Işıklı Mandal Buton 0-1 Sarı LED 24V	1NO	30.00 TL
PB0-AK123M5	Yeşil	Işıklı Mandal Buton 0-1 Yeşil LED 220V	1NO	30.00 TL
PB0-AK124M5	Kırmızı	Işıklı Mandal Buton 0-1 Kırmızı LED 220V	1NC	30.00 TL
PB0-AK125M5	Sarı	Işıklı Mandal Buton 0-1 Sarı LED 220V	1NO	30.00 TL
PB0-AK133B5	Yeşil	Işıklı Mandal Buton 1-0-2 Yeşil LED 24V	2NO	35.00 TL
PB0-AK134B5	Kırmızı	Işıklı Mandal Buton 1-0-2 Kırmızı LED 24V	2NC	35.00 TL
PB0-AK135B5	Sarı	Işıklı Mandal Buton 1-0-2 Sarı LED 24V	2NO	35.00 TL
PB0-AK133M5	Yeşil	Işıklı Mandal Buton 1-0-2 Yeşil LED 220V	2NO	35.00 TL
PB0-AK134M5	Kırmızı	Işıklı Mandal Buton 1-0-2 Kırmızı LED 220V	2NC	35.00 TL
PB0-AK135M5	Sarı	Işıklı Mandal Buton 1-0-2 Sarı LED 220V	2NO	35.00 TL
PB0-AG21	Siyah	Anahtarlı Mandal Buton Kalıcı 0-1	1NO	30.00 TL
PB0-AG33	Siyah	Anahtarlı Mandal Buton Kalıcı 1-0-2	2NO	35.00 TL

PBO SERİSİ 22mm BUTON VE SİNYALLER



KOD	RENK	AÇIKLAMA	KONTAK	FİYAT
PBO-AL73415	 Kırmızı+Yeşil	İkiz Buton	1NO+1NC	23.00 TL
PBO-AW734B5	 Kırmızı+Yeşil	Işıklı İkiz Buton LED 24V	1NO+1NC	34.00 TL
PBO-AW734M5	 Kırmızı+Yeşil	Işıklı İkiz Buton LED 220V	1NO+1NC	34.00 TL
PBO-LS22-24R	 Kırmızı	LED Sinyal 22mm Kırmızı 24VAC-DC	- -	5.20 TL
PBO-LS22-24G	 Yeşil	LED Sinyal 22mm Yeşil 24VAC-DC	- -	5.20 TL
PBO-LS22-24Y	 Sarı	LED Sinyal 22mm Sarı 24VAC-DC	- -	5.20 TL
PBO-LS22-24W	 Beyaz	LED Sinyal 22mm Beyaz 24VAC-DC	- -	6.10 TL
PBO-LS22-24B	 Mavi	LED Sinyal 22mm Mavi 24VAC-DC	- -	6.10 TL
PBO-LS22-220R	 Kırmızı	LED Sinyal 22mm Kırmızı 220VAC	- -	5.20 TL
PBO-LS22-220G	 Yeşil	LED Sinyal 22mm Yeşil 220VAC	- -	5.20 TL
PBO-LS22-220Y	 Sarı	LED Sinyal 22mm Sarı 220VAC	- -	5.20 TL
PBO-LS22-220W	 Beyaz	LED Sinyal 22mm Beyaz 220VAC	- -	6.10 TL
PBO-LS22-220B	 Mavi	LED Sinyal 22mm Mavi 220VAC	- -	6.10 TL
PBO-B22-24	 Siyah	Buzzer 24VAC-DC	- -	24.00 TL
PBO-B22-220	 Siyah	Buzzer 220VAC-DC	- -	24.00 TL
PBO-LB22-24R	 Kırmızı	Işıklı Buzzer 24VAC-DC	- -	26.00 TL
PBO-LB22-220R	 Kırmızı	Işıklı Buzzer 220VAC-DC	- -	26.00 TL
PBO-LS22-220RG	 Kırmızı+Yeşil	Çift Renk Sinyal Kırmızı-Yeşil 220VAC	- -	16.00 TL
PB-LS22-220R	 Kırmızı	Din LED Sinyal Kırmızı 220VAC	- -	13.00 TL
PB-LS22-220G	 Yeşil	Din LED Sinyal Yeşil 220VAC	- -	13.00 TL
PB-LS22-220Y	 Sarı	Din LED Sinyal Sarı 220VAC	- -	13.00 TL



PBO SERİSİ 22mm BUTON VE SİNYAL AKSESUARLARI



KOD	RENK	AÇIKLAMA	KONTAK	FİYAT
PB-BK 01Y	Sarı-Siyah	Buton Kutusu 1li Sarı-Siyah	- -	14.60 TL
PB-BK 01G	Gri-Siyah	Buton Kutusu 1li Gri-Siyah	- -	14.60 TL
PB-BK 02G	Gri-Siyah	Buton Kutusu 2li Gri-Siyah	- -	19.50 TL
PB-BK 03G	Gri-Siyah	Buton Kutusu 3lü Gri-Siyah	- -	24.30 TL
PB-BK 04G	Gri-Siyah	Buton Kutusu 4lü Gri-Siyah	- -	35.00 TL
PB-BK 05G	Gri-Siyah	Buton Kutusu 5li Gri-Siyah	- -	48.80 TL



PB0-KB01	NC KONTAK	NC KONTAK	1NC	6.50 TL
PB0-KB10	NO KONTAK	NO KONTAK	1NO	6.50 TL



PB0-A-M5		Buton LED kontak 220VAC	- -	13.00 TL
PB0-A-B5		Buton LED kontak 24VAC-DC	- -	13.00 TL

PB-SB22	Silikon Buton Koruma Başlığı 22mm Şeffaf	- -	4.50 TL
PB-BSA	Buton Somunu Sıkma Aparatı	- -	16.30 TL
PB-ES60	Acil Stop Etiket 60mm	- -	5.20 TL
PB-ES90	Acil Stop Etiket 90mm	- -	5.50 TL
PB-BR2515	Buton Rozeti 25x15mm	- -	1.65 TL
PB-KT22	Kör Tapa+Somun 22mm	- -	3.25 TL
PB-BKO	Buton Koruma Kapağı Oval	- -	5.20 TL
PB-BKY	Buton Koruma Kapağı Yuvarlak	- -	5.20 TL



PB-SB22



PB-BSA



PB-ES60



PB-BR2515



PB-KT22



PB-BKO



PB-BKY

A series of horizontal dashed lines for writing notes.

NOTLAR

A series of horizontal dashed lines for writing notes.

A series of horizontal dashed lines for writing notes.

YENİ ÜRÜN!

DESIGN SERİSİ TEPE FANLARI



**TÜRKİYE'DEN
DÜNYANIN DÖRT BİR YANINA!**

- ALGERIA
- AUSTRALIA
- AZERBAIJAN
- BOSNIA HERZEGOVINA
- BULGARIA
- COLOMBIA
- CZECH REPUBLIC
- CROATIA
- EGYPT
- ENGLAND
- ECUADOR
- FINLAND
- GERMANY
- GREECE
- HONDURAS
- HUNGARY
- ICELAND
- INDONESIA
- IRAQ
- IRAN
- IRELAND
- ISRAEL
- ITALY
- JORDAN
- KUWAIT
- LATVIA
- LEBANON
- LIBYA
- MOROCCO
- MALDIVES
- MEXICO
- NETHERLAND
- PALESTINE
- PAKISTAN
- PERU
- POLAND
- PORTUGAL
- QATAR
- ROMANIA
- RUSSIA
- SAUDI ARABIA
- SERBIA
- SPAIN
- SOUTH AFRICA
- SRI LANKA
- SWITZERLAND
- TAIWAN
- THAILAND
- TUNISIA
- UKRAINE
- UAE
- VIETNAM

PLASTİM ELEKTRİK MALZEMELERİ İMALAT SAN. TİC. LTD. ŞTİ.

MERKEZ: Perpa Elektrokent A Blok Kat: 2 No: 37 34384 Okmeydanı - İstanbul / Türkiye
Tel: +90 212 210 17 10 Faks: +90 212 221 72 37

FABRİKA 1: Alipaşa Mahallesi Boztepe Sokak No: 5 34570 Silivri - İstanbul / Türkiye
FABRİKA 2: İkitelli OSB Fatih Sanayi Sitesi 4A Blok No: 3-4 34306 Başakşehir - İstanbul / Türkiye

info@plastim.com.tr

www.plastim.com.tr